



**NIEUWKOOP**

METEN.NL

# USER MANUAL



## CL3040

CHLORINE CONTROLLER, PANEL,  
2 RELAY



TO MEASURE  TO KNOW



Scales : 0/2,000/20,00 ppm  
 Temperature scales : 0.0/50.0 °C  
                                   32.0/122.0 °F  
 Power Supply : 86/264 Vac  
 Firmware : R 1.0x  
 Cod. 280067671 Revision C 05/18

## INDEX

1	PRODUCT PRESENTATION.....	3
1.1	Functional purpose of the unit .....	3
1.2	Functional principles .....	3
1.3	Sensors and accessories .....	4
2	GENERAL WARNINGS AND INFORMATION FOR ALL USERS .....	5
2.1	Warranty .....	5
2.2	After sales service .....	5
2.3	CE marking .....	5
2.4	Safety warnings .....	5
3	INSTRUCTION MANUAL CONTENTS .....	6
3.1	Manual revision .....	6
3.2	Symbols .....	6
3.3	How to read the instruction manual .....	7
3.3.1	Using the instrument on the plant .....	7
3.3.2	Plant maintenance staff .....	8
3.3.3	Installing the instrument in the plant .....	8
4	SPECIFICATIONS .....	9
4.1	Functional specification .....	9
4.2	Technical specifications .....	11
5	OPERATING PROCEDURES .....	15
5.1	Keyboard.....	15
5.2	Operating instructions .....	16
5.2.1	Chlorine or dissolved ozone measuring .....	16
5.2.2	Temperature measuring .....	16
5.2.3	Set up parameters .....	16
5.2.4	Configuration parameters .....	17
5.2.5	Firmware release .....	17
5.3	Instruction for the maintenance staff .....	17
5.3.1	Preliminary operations .....	17
5.3.2	Measuring operations.....	18
5.3.3	Chlorine or dissolved ozone calibration .....	18



---

5.3.4 Set point calibration .....	19
5.3.5 Temperature calibration .....	19
5.3.6 Manual temperature compensation .....	20
5.3.7 Set-up .....	20
5.3.8 Maintenance of the unit .....	22
5.3.9 Maintenance of the sensor .....	22
5.4 Instructions for the plant engineer .....	23
5.4.1 Safety instruction .....	23
5.4.2 Configuration .....	23
6 INSTALLATION .....	26
6.1 Packing list .....	26
6.2 Unpacking .....	26
6.3 Storage and transportation .....	26
6.4 Installation of the unit .....	26
6.5 Installation of the sensor .....	26
6.6 Electrical installation .....	27
6.6.1 Connecting the power .....	27
6.6.2 Connecting the sensor .....	27
6.6.3 Connecting the temperature sensor .....	28
6.6.4 Connecting the analog output .....	28
6.6.5 Connecting the pumps, solenoids and alarms .....	29
6.6.6 Connecting the logic input .....	30
7 DISPOSAL .....	30
Warranty certificate .....	33
Repairs .....	33
Technical support.....	34



## 1 PRODUCT PRESENTATION

### 1.1 FUNCTIONAL PURPOSE OF THE UNIT

The basic system for chlorine/dissolved ozone monitoring is made of three important parts:

- the controller described in this instruction manual;
- the sensor;
- the flow cell.

The instrument has the necessary electric circuits and firmware to perform the following functions:

- 1) as the proper sensor is connected, it displays the chlorine/dissolved ozone concentration values;
- 2) if a Pt100 or Pt1000 temperature sensor is connected, it will display the temperature values;
- 3) it performs an automatic or manual temperature compensation;
- 4) if dosing pumps or solenoids are connected to the specific relays, it will automatically adjust the conductivity values;
- 5) if the measure goes outside the low/high limit values, it will give an alarm;
- 6) it provides an analog output for recording and acquiring the chlorine/dissolved ozone values;
- 7) to receive an external free voltage contact that activates the alarm or the hold condition.

### 1.2 FUNCTIONAL PRINCIPLES

The measuring of the free chlorine, chlorine dioxide or dissolved ozone is done by means of two types of sensors:

- polarographic cell with two electrodes immersed in the suitable electrolyte and with selective membrane,
- potentiostatic sensor with three electrodes.

A polarization voltage is applied to the anode and cathode of the polarographic cell in order to get an electrical current into the electrolyte, proportional to the chlorine/d.ozone concentration.

A polarization voltage is applied to the anode and counter electrode of the potentiostatic sensor in order to get an electrical current into the sample, proportional to the chlorine/d.ozone concentration.

A reference electrode allows the compensation of the ORP and resistance effects.

As a result the measuring is very accurate even at low concentration levels.

The current through the polarographic or potentiostatic cell is effecting a chlorine/d.ozone consumption, to be renewed by a constant liquid flow.

If the liquid is not regularly renewed the readout will decrease slowly to zero.

This instrument features a manual or automatic temperature compensation, referred to temperature of 20 °C or 25 °C.

### 1.3 SENSORS AND ACCESSORIES

The listed articles are the most commonly used ones. They must be ordered separately.



Sensors and accessories for heavier and particular applications are also available.



*SZ 283 potentiostatic sensor for free chlorine and d.ozone, 3 m cable*



*SZ 7231 flow cell for SZ283 sensor and temperature*

*SZ 7233 flow cell for SZ283, pH, redox and temperature*



*SZ 7251 flow cell for SZ283 with autoclean*



*CL 7901 polarographic sensor for free chlorine, with flow cell and spares*

*OZ 7901 polarographic sensor for d.ozone, with flow cell and spares*

## **Temperature sensor**

*SP 514 Pt100 sensor for flow cell*

## **Enclosures**

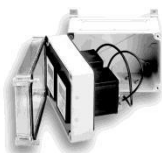

*BC 931.2 IP 65 enclosure for one instrument*

*BC 931.3 IP 65 enclosure for two instruments*



## 2 GENERAL WARNINGS AND INFORMATION FOR ALL USERS

### 2.1 WARRANTY

This product is guaranteed for all manufacturing defects.

Please take a look at the terms and conditions described on the Warranty Certificate at the end of the manual.

### 2.2 AFTER SALES SERVICE

Nieuwkoop B.V./B&C offers to all of its Customers the following services:

- a free of charge Technical Assistance over the phone for problems regarding installation, calibration and regular maintenance;
- a Repairing Service in our Aalsmeer (Netherlands) headquarter for all types of damages, calibration or for a scheduled maintenance.

Please take a look at the Technical Support data sheet at the end of the manual for more details.

### 2.3 CE MARKING

This instrument is manufactured according to the following European Community directives:

- 2011/65/EU "Restriction of the use of certain hazardous substances in electrical and electronic equipment"
- 2014/35/EU "Low Voltage" LV
- 2014/30/EU "Electromagnetic compatibility" EMC
- EN 61010-1/2011 "Low Voltage" LV
- EN 61326-1/2013 "Electromagnetic compatibility" EMC
  - Controlled electromagnetic environment
- EN 55011/2009 "Radio-frequency disturbance characteristics"
  - Class A (devices for usage in all establishment other than domestic)
  - Group 1 (Industrial equipment that do not exceed 9kHz)

The marking  is placed on the packaging and on the S/N label of the instrument.

### 2.4 SAFETY WARNINGS

It is important to underline the fact that electronic instruments are subject to accidents. For this, it is important to take all necessary precautions to avoid damages caused by malfunctions.

All types of operations must be performed by authorized and trained staff.

The use of this controller must respect the parameters described in Chapter 4.2 "Technical specification", so to avoid potential damages and a reduction of its operating life.



### 3 INSTRUCTION MANUAL CONTENTS

This chapter describes the manual and gives suggestions to all users on how to read it and use it.

The manual is written according to the following norms:

- UNI 10893 "Instructions for use".
- UNI 10653 "Quality of product technical documentation".

#### 3.1 MANUAL REVISION

This chapter shortly describes the differences between previously released versions of the same manual, so to help users that are already familiar with the product.

Rev. A First emission.

Rev. B Updates back panel drawing

Rev. C Updated CE marking and alarm limits

#### 3.2 SYMBOLS

Throughout the manual You may find the following symbols, which are both dictated by a Norm or that are simply conventional:

<b>Symbol</b>	<b>Meaning</b>
	<p>Attention: pay great attention to what written next to this symbol</p>
<p>-----  <b>WARNINGS</b>            -----</p>	<p>This symbol is used to warn users that if the instructions are ignored or not correctly followed, damage to the instrument can be caused</p>
<b>Note</b>	<p>This symbol is to invite the user to pay particular attention to a specific section of the manual.</p>
“*”	<p>This symbol can be found in those chapters where there have been changes from the previous releases.</p>





### 3.3 HOW TO READ THE INSTRUCTION MANUAL

The manual includes all necessary information to fully comprehend the product, to install it correctly, to use it and preserving it, and finally to achieve the performances for which You have selected it and purchased it.

The manual is intended for experienced and prepared personnel, who has knowledge of electronic instrumentations and industrial plants' typical operations.

The index guides the reader through the chapters and through the contents that he wishes to know or exploit.

In particular, the first chapters describe the general characteristics and they allow the reader to become more familiar with the product by describing its accessories and its use.

The user can then verify if he/she has the necessary know-how to use the controller.

As described in the following chapters, the instrument was designed by keeping in mind three different kinds of users: generic use (*end user*), control (*maintenance staff*), installation (*plant engineer*).

#### **Note**

*Maintenance staff could be more interesting in the chapters regarding:*

- users instructions;
- calibration;
- maintenance;
- warranty/repair terms and conditions.

*The plant engineer will have to read the chapters and look at the application drawings in order to:*

- verify that the technical and functional characteristics are conformed with the plants requirements;
- verify that the environmental and climatic conditions required by the instruments are respected;
- make the correct electronic connections;
- become familiar with the instrument's firmware;
- configure the instrument according to the application;
- run all of the necessary tests before starting the instrument ;
- calibrate the instrument once the sensor is connected.

#### 3.3.1 Using the instrument on the plant

For the generic use, the end user can operate with a locked keyboard (suggested mode and to be set by maintenance staff). By this, he can control the data provided without the possibility of changing the configured set points.





### 3.3.2 Plant maintenance staff

Maintenance staff can select the operating values, by setting the desired parameters of the “set up” menu and after inserting the password. The user’s access to calibration, set point and alarm settings can also be enable.

The location of this set parameters can be seen in the right column of the Technical Specifications table (Chapter 4.2) and they are identified by a letter “S” followed by a number.

The operations that need to be done during the start-up and the periodical tests are the following:

- to allow only the visualization of the measures during the normal use;
- to calibrate the sensors by means of ZERO and SENS keys;
- to set the following parameters:
  - set point 1 and 2 by means of SET 1 and SET 2 keys
  - temperature value in °C or °F
  - manual temperature compensation value
  - temperature coefficient
  - set point 1 and 2 delay
  - min. and max. alarm value
  - alarm delay
- activate/deactivate logic input;
- to modify password to access set up

### 3.3.3 Installing the instrument in the plant

The plant engineer, by inserting the access password and by setting and modifying the “configuration” parameters, will be able to select the necessary functions required by the plant.

The location of this set parameters can be seen in the right column of the Technical Specifications table (Chapter 4.2) and they are identified by a letter “C” followed by a number.

The configuration that need to be done during the instrument installation are the following:

- cell type;
- measuring scale;
- measuring unit;
- polarization voltage;
- Pt100 or Pt1000 sensor;
- min. and max. (Lo/Hi) function of set-point 1 and 2;
- activated/deactivated (Act/Dea) condition of alarm relay;
- 0/20 mA or 4/20 mA output range;
- hold/alarm function for logic input;
- password changing to access the configuration.



## 4 SPECIFICATIONS

### 4.1 FUNCTIONAL SPECIFICATION

#### Display

The instrument has a 7 segments and 4 digits LED display. The display shows the measures vales and the messages to the operator.

In particular, the messages scroll on the display and they are preceded by the corresponding number of the Technical Specifications tables (Chapter 4.2).

After a 3' stand-by, the display goes back to the main measuring.

#### Keyboard

The instrument has 8 keys, which allow to access all of available functions.

The upper keys are for zero and sensitivity calibration and to confirm the set points value. All of this functions can be then protected by means of password.

The other keys will be described in the following chapters.

#### Input

The controller can measure the free chlorine, chlorine dioxide or d.ozone concentration and the temperature.

The measuring unit ppm or mg/l is indicated by the Led positioned to the right of the display.

The concentration is measured by means of a potentiostatic cell or a polarographic cell provided with a selective membrane.

The temperature value, in °C or °F, can be measured with a Pt100 or Pt1000 temperature sensor; with 2 or 3 wires connection depending to the distance between sensor and controller.

#### Measuring scales

The instrument features the selection of three scales as shown in the chapter 4.2 "Specifications".

#### Temperature compensation

The instrument shows the temperature value and it allows the manual or automatic temperature compensation.

In case the temperature sensor is absent or it is malfunctioning, the controller turn automatically to manual compensation and it will show the value of compensation temperature.

The temperature coefficient can be selected according to the specific applications.

#### Set-points

The instrument has two independent set-points which can be programmed across the whole scale to activate the correspondent relay contacts (SPST).



When a relay is activated the corresponding Led, placed to the left side of the display, will light up. During the phase of activated delay, the LED will flash.

Thanks to the specific front panel keys SET 1 and SET 2, setting the set point value is very simple. A password can be set in order to avoid that other users may change the settings.

For each relay, it is possible to select:

- min/max function;
- delay.

### Alarm

The instrument has an alarm relay, which contact are SPDT type.

The alarm condition can be configured for:

- higher or lower conductivity values compared to the set points;
- logic input signal coming from an external device (if this function is activated);

The alarm status can be seen on the LED marked ALM placed to the left of the display.

During the phase of activated delay, the LED will flash.

The operator can set the activated/deactivated (Act/Dea) status of relay corresponding to the alarm condition and the delay function.

### Analog output

The instrument has an isolated analog output to send the measure value. The output can be programmed 0/20 mA or 4/20 mA and it is displayed by the main measure.

The galvanic isolated output allows the controller to communicate with a PLC or with a recorder and it does not need an external power supply.

### Logic input

The instrument is equipped with a logic input to connect to external dry contacts.

The logic input function can be activated or deactivated from the set up menu.

The input function can be selected Hold/Alarm, which features are described in table 6.0 of Chapter 4.2 "Technical specifications", and it is selected in the configuration menu.

### Universal power supply

The instrument can operate with an 85/264 Vac power supply.

### Power supply option 9/36 Vdc or 24 Vac

By installing this option, the instrument can be used with a 9/36 Vdc or 24 Vac power supply



### Set up

The instrument has the set up menu protected by a specific password.

In the menu, it is possible to deactivate the functions of sensors calibration, set points values and parameters changing, alarm and logic input parameters changing.

### Configuration

The instrument has a configuration menu protected by a specific password.

In the menu, it is possible to select the type of cell, the measuring scale, the measuring unit, the manual temperature, the temperature coefficient and the temperature sensors, to select the min/max (Lo/Hi) set point functions, the alarm relay activation type (Act/Dea), the analog output range and the logic input function.

## 4.2 TECHNICAL SPECIFICATIONS

The display number is next to the factory values in the following tables.

SETUP parameters are indicated by : "S x.y"

CONFIGURATION parameters are indicated by: "C x.y"

x=table section y=sequence 1..2..3..4..etc.

Underlined words in the tables correspond to scrolling display messages.

1.0 MAIN MEASURING	Factory value	Display
TYPE OF MEASURING Free chlorine/chlorine dioxide/d.ozone  Cell: potentiostatic (3 wires) ( <u>POTe/POLA</u> ) polarografica (2fwires)	<u>POTe</u>	C1.1
Scales: Scale    Resolution    Under Range    Over Range 2.000    0.001            0.100            2.100 20.00    0.01             1.00             21.00 200.0    0.1              10.0             210.0	<u>20.00</u>	C1.2
Measuring unit: ppm, mg/l ( <u>PPM/MGL</u> )	<u>PPM</u>	C1.3
Potentiostatic cell: Input current at 20°C: 2000 nA/ppm (mg/l) Sensitivity: 12.5% / 250% (250/5000 nA/ppm) Zero: +/- 2000 nA Polarization: -1000/1000 mV		
Polarographic cell: Input current at 20°C: 160 nA/ppm (mg/l) Sensitivity: 12.5% / 250% (20/400 nA/ppm) Zero: +/- 200 nA Polarization: -1000/1000 mV	100% 0 nA -200 mV	1.2 1.1 C1.4



2.0 TEMPERATURE MEASURING	Factory value	Display
TYPE OF MEASURING		
Temperature		
Input: RTD Pt100/Pt1000	Pt100	C2.1
Connection: 3 wires		
Measuring unit: °C/°F	°C	S2.1
Measuring and compensation range: 0.0/50.0°C (32.0/122.0°F)		
Resolution: 0.1°C (0.1°F)		
Under range: -2.0°C (28.4°F)		
Over range: 52.0°C (125.5°F)		
Zero adjustment: +/- 2.0°C (+/- 3.6°F)	0°C (0°F)	2.1
Manual temperature: 0/50°C (32/122°F)	20°C (68°F)	S2.2
Temperature reference: 20 °C		
Temperature coefficient: 0.00/4.00%/°C	2.0%/°C	S2.3

3.0 SET POINT	Factory value	Display
SET POINT 1		
Action: ON-OFF		
Set point (function of the scale): 0.00/20.00	0	3.1
Hysteresis (function of the scale): ± 0.20		
Delay: 0.0/100.0 seconds	0.2 s	S3.1
Function: Lo/Hi (Min/Max)	Lo	C3.1
Relay contacts: SPST 220V 5A resistive		
SET POINT 2		
Action: ON-OFF		
Set point (function of the scale): 0.00/20.00	0	3.2
Hysteresis (function of the scale): ± 0.20		
Delay: 0.0/100.0 seconds	0.2 s	S3.2
Function: Lo/Hi (Min/Max)	Hi	C3.2
Relay contacts: SPST 220V 5A resistive		



4.0 ALARM	Factory value	Display
Low value (function of the scale):	0.00/20.00	-1.00
High value (function of the scale):	0.00/20.00	21.00
Hysteresis (function of the scale):	± 0.05	
Delay:	0.0/100.0 seconds	1.0 s
Relay status (activated/deactivated): <u>Act./dEA.</u>	<u>Act.</u>	S4.1 S4.2 S4.3 C4.1
Relay contacts:	SPDT 220V 5A resistive	

5.0 ANALOG OUTPUT	Factory value	Display
Range:	0-20/4-20 mA	0-20 mA
Under/Over range (0-20):	0.00/20.50mA	
Under/Over range (4-20):	3.50/20.50mA	
Response time:	2.5 seconds for 98%	
Isolation:	250 Vac	
R max:	600 ohm	
EXTERNAL POWER IS NOT NEEDED		

6.0 LOGIC INPUT	Factory value	Display
Logic input: activated/deactivated	( <u>On/OFF</u> )	<u>OFF</u>
Logic input function:	<u>HoLd/ALAr.</u>	<u>HoLd</u>
HOLD conditions:		
Analog output keeps the value	(HOLD)	
Set points keep the status	(HOLD)	
Alarm state deactivated	(OFF)	
ALARM conditions:		
Analog output activated	(RUN)	
Set points deactivated	(OFF)	
Alarm state activated	(ON)	
External contacts must be free voltage		



10.0 SETUP PARAMETERS		Factory value	Display
Password to access the SETUP	<u>(0/999)</u>	0	10.1
Calibration and set point adjustment	<u>On/OFF</u>	<u>On</u>	S1.1
Temperature measuring unit	<u>°C/°F</u>	<u>°C</u>	S2.1
Manual temperature		20.0°C	S2.2
Temperature coefficient		2.00%/°C	S2.3
Delay set1		0.2 s	S3.1
Delay set2		0.2 s	S3.2
Alarm LO (low value)		-1.00	S4.1
Alarm HI (high value)		21.00	S4.2
Delay alarm		1.0 s	S4.3
Logic input	<u>On/OFF</u>	<u>OFF</u>	S6.1
Modify password to SETUP access		0	S10.1

11.0 CONFIGURATION PARAMETERS		Factory value	Display
Password to access CONFIGURATION	<u>(0/999)</u>	0	11.1
Cell type	<u>POte./POLA.</u>	<u>POtE</u>	C1.1
Scale	<u>2.000/20.00/200.0</u>	<u>20.00</u>	C1.2
Measuring unit	<u>PPM / MGL</u>	<u>PPM</u>	C1.3
Polarization	-1000/1000mV	-200mV	C1.4
Temperature sensor	<u>Pt100/Pt1000</u>	<u>Pt100</u>	C2.1
Set point 1 function	<u>Lo/Hi</u>	<u>Lo</u>	C3.1
Set point 2 function	<u>Lo/Hi</u>	<u>Hi</u>	C3.2
Alarm relay status	<u>Act./dEA.</u>	<u>Act.</u>	C4.1
Analog output range	<u>0-20/4-20</u> mA	<u>0-20</u> mA	C5.1
Logic input function	<u>HoLd/ALAr.</u>	<u>HoLd</u>	C6.1
Modify password to CONFIGURATION access		0	C11.1

### GENERAL SPECIFICATIONS

Display:	LED 7 segments and 4 digits
Led indicators:	-set1 and set2 relay status -alarm status -logic input contact status -measuring unit ppm -measuring unit mg/l
Operating temperature:	0/50°C
Humidity:	95% without condensation
Power supply:	85/264 Vac 50/60 Hz
Isolation:	4000 Vdc (2350 Vac) between primary and secondary (IEC 348)
Power consumption:	6 VA max.
Terminal blocks:	extractable
Weight:	450 g
Dimensions: 9	6 x 96 x 104 mm including frame.
Dimensions (internal to switch board):	90 x 90 x 95 mm



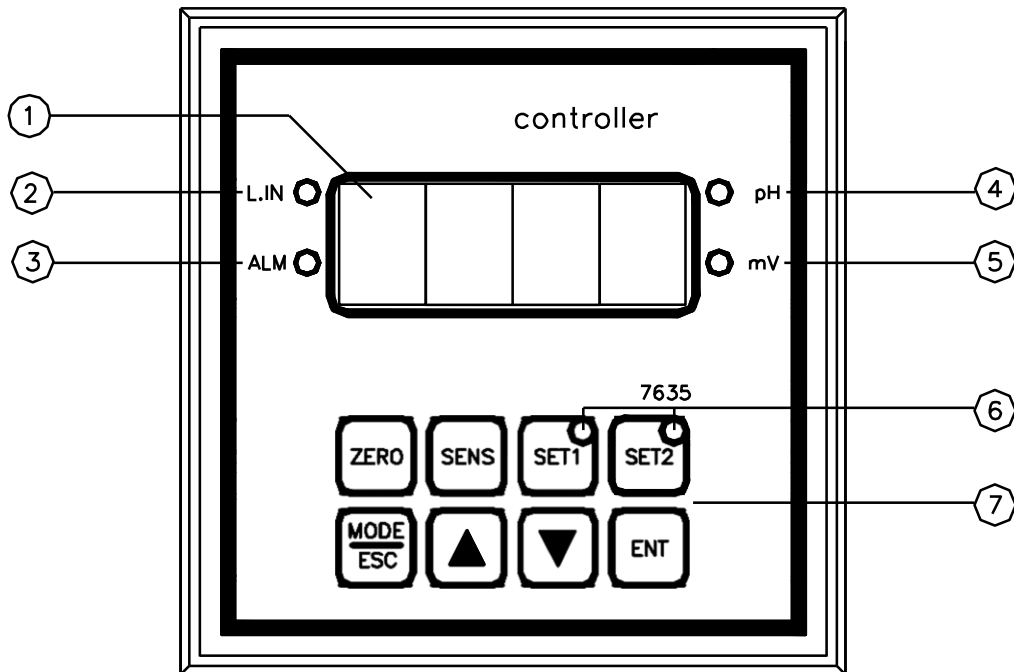

## 5 OPERATING PROCEDURES







- |                                      |                                   |
|--------------------------------------|-----------------------------------|
| 1. Values and messages display       | 4. Selected measuring unit (ppm)  |
| 2. Logic input contact visualization | 5. Selected measuring unit (mg/l) |
| 3. Active alarm visualization        | 6. Set point relay activated      |
|                                      | 7. Keyboard                       |

Fig.1

### 5.1 KEYBOARD

 "Zero"	Starts zero calibration
 "Sens"	Starts sensitivity calibration
 "Set1"	Starts set point 1 calibration
 "Set2"	Starts set point 2 calibration

 "Mode - Esc"	- Visualizes instrument functions - Exit without changing the values
 "Up"	- Increase the values - Changes the options
 "Down"	- Decrease the values - Changes the options
 "Enter"	- Enter the new values - Starts the visualized function





## 5.2 OPERATING INSTRUCTIONS

### 5.2.1 Chlorine or dissolved ozone measuring

The display shows the main measure values as selected in the configuration menu. The front panel LED is lit according to the selected measure.

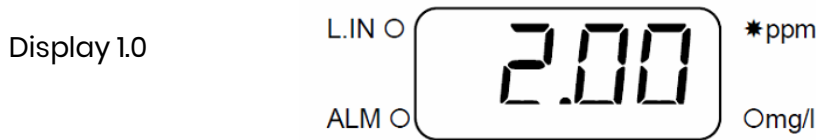

If the measuring value is under range/over range, the following messages will appear: `- o r -` and `_ u . r . _`.

From this display 1.0 it is possible to start the sensors calibration procedure, the set points setting (if those functions have been enabled in the set up menu).

From this display 1.0 it is possible to start the sensors calibration procedure, the set points setting (if those functions have been enabled in the set up menu).



by pressing the key, the LED 4 or 5 on the front panel are switched off and the analog output range and the expected current on the load are displayed.

`out 0-20 mA 10.00` or `out 4-20 mA 10.00`

### 5.2.2 Temperature measuring



By pressing the key from the 1.0 display, the unit will show the message `(°C o °F)`, if the RTD is not connected the message `NaN` and the temperature value (actual value or the manual value selected in the display S2.2).

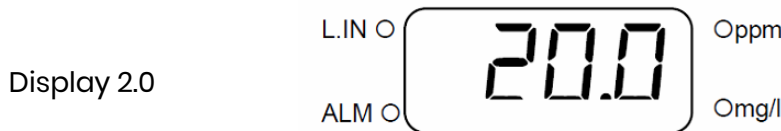

From this display it is possible the access to the calibration procedure of the temperature probe if this function is enabled by the operator.

### 5.2.3 Set up parameters

The set up parameter changing can be enabled/disabled by the operator.



By pressing two times the key from the 1.0 display, the unit will show the message `SET-UP PRESS ENT` and it is possible to access to the menu reserved to maintenance staff (set-up)



Display 10.0

L.IN ○	5E6-	○ppm
ALM ○		○mg/l

### 5.2.4 Configuration parameters



By pressing three times the key from the 1.0 display, the unit will show the message `CONF iG. PrESS Ent` and it is possible to access to the menu reserved to the plant engineer (configuration)

Display 11.0

L.IN ○	CONF	○ppm
ALM ○		○mg/l

### 5.2.5 Firmware release



By pressing four times the key from the 1.0 display, the unit will show the message `CL7635 r 1.00` (it shows the unit p/n and the release of the firmware installed in the unit).

Display 12.0

L.IN ○	r 1.00	○ppm
ALM ○		○mg/l



By pressing the key, the unit turn back to the main display.

## 5.3 INSTRUCTION FOR THE MAINTENANCE STAFF

### 5.3.1 Preliminary operations

All the functioning operations must be done with sensor connected to the unit.

Verify if the configuration, the set point and the alarm parameter are suitable for the current application.

Follow the procedures described in the chapter 5.3.7 to verify the parameters without modifying the values.

The display, LED and keys in the front panel allow the operator to perform the preliminary check.

A lit display indicates that the unit s powered and the power circuits work correctly.



### 5.3.2 Measuring operations

In order to correctly operate the system, remember to verify the following:

- sensors are installed and in contact with the liquid;
- analog output if necessary;
- eventual actuation of the relays 1 and 2;
- alarm relay if necessary;
- logic input if necessary;
- power supply and ground;

Power the unit and read the chlorine/d.ozone concentration value and the status of the set points. If sensors are connected correctly as described in chapter 6 "Installation", the system will operate properly and it will only need the calibration and the set point/ alarm values setting.

### 5.3.3 Chlorine or dissolved ozone calibration

Install the cell into the flow cell and connect it to the instrument.

By keeping the cell in air or dipped into a sample without chlorine/d.ozone, the display will show zero. If the readout is different than zero it is possible to perform the following zero calibration



By pressing the key, the unit will show the message

**ZERO CAL.** followed by the actual chlorine or dissolved ozone value, or **CAL. OFF** if the calibration function has been disabled into the set up menu (display S1.1).



press to confirm and to end the calibration.

**UPdARE** or **ZERO Error** messages will appear.

The message of error must be confirmed if the calibration has not been ended successfully.

The chemical calibration is performed by adjusting the sensitivity of the instrument in order to read on the display the same value of the sample concentration.

The user must know the concentration of the sample or he must measure by means of a field or laboratory equipment. (example through DPD).

Follow the next steps:



By pressing the key, the unit will show the message

**SENS. CAL.** followed by the actual concentration value, or **CAL. OFF** if the calibration function has been disabled into the set up menu (display S1.1).



or press the keys to change the value according to sample concentration,



press to confirm and to end the calibration



**UPdATE** or **SEnS. Error** messages will appear.

The message of error must be confirmed if the calibration has not been performed.

If the operator needs to turn to the factory calibration of the zero or the sensitivity

   press the three keys together instead of using the   keys



The following messages will appear **RESEt ZERo** or **RESEt SEnS**.

The error messages during the calibration inform the operator about the bad condition of the cell.

The zero > 200 nA (polarographic) or zero > 2000 nA (potentiostatic) will show the message **ZERo Error**, to indicate the pollution of the sensor, the needing of the sensor maintenance or problems on the cable.

The sensitivity < 12.5% or > 250% will show the message **SEnS. Error**, to indicate the needing of sensor maintenance.

### 5.3.4 Set point calibration

 or  By pressing the key, the unit will show the message **SEt 1 (SEt2) Hi** or **Lo** (depending on the configuration done in display C3.1 o C3.2) followed by the actual value,

 or  press the keys to change the value

**CAL. OFF** will appear if the calibration has been disabled in the set up display S1.1).

 press to confirm and to end the calibration.

 press the key to exit from the procedure without changing the data (this key allows to exit from all the procedure without changing the previous data/setting).

### 5.3.5 Temperature calibration

 By pressing the key from the main display, the unit will access the temperature readout.

 By pressing the key, the unit will show the message **ZERo CAL.** followed by the actual value, or **CAL. OFF** if the calibration function has been disabled into the set up menu (display S1.1).

 or  press the key to change the value

 press to confirm and to end the calibration

**UPdATE** message or **ZERo Error** will appear.



The message of error must be confirmed if the calibration has not been performed.  
If the operator needs to turn to the factory calibration of the zero

   press the three keys together instead of using the   keys

### 5.3.6 Manual temperature compensation

If the RTD is not installed, the unit will display the manual temperature compensation value.  
Refer to the chapter 5.3.7 display S2.2 in order to change the manual temperature value.

### 5.3.7 Set-up



By pressing two times the key from display 1.0, the unit will show the message  
**SEt-UP PrESS ENT** (display 10.0).



By pressing the key the unit will require the user to insert the password (display 10.1)  
**PASS ---**



or , press the key to insert the password



press to confirm the password and to enter the set up menu (if the password is not used, press again the key ).

Into the set up menu the keys have the following functions:



or  to change values or options shown on the display



to confirm the value/option  
(if value/option have been modified it will appear the message **UPDATE**)



to exit from the procedure and to turn to display 10.0 without any changing.

#### *Display S1.1: Inhibition of zero/sensitivity calibration and set point changing*

The following message will appear:

**1.1 CAL. Funct ion** followed by the actual setting (**On/OFF**)

*Display S2.1: Selection of the temperature measuring unit*

The following message will appear:

**2.1 tEMP. UNIT** followed by the actual setting (**°C/°F**)

*Display S2.2: Manual temperature compensation value  
(in case the RTD is not connected to the unit)*

The following message will appear:

**2.2 MAN. tEMP.** followed by the actual setting (**°C/°F**) and the actual value.

*Display S2.3: Temperature coefficient*

The following message will appear:

**2.3 tC.** followed by the current value

*Display S3.1: Delay (in seconds) of the set point 1 relay*

The following message will appear:

**3.1 SET 1 DELAY** followed by the actual value.

*Display S3.2: Delay (in seconds) of the set point 2 relay*

The following message will appear:

**3.2 SET 2 DELAY** followed by the actual value.

*Display S4.1: Minimum alarm value*

The following message will appear:

**4.1 LO ALARM** followed by the actual value (the unit is shown by the corresponding LED 4 or 5 on the front panel)

*Display S4.2: Maximum alarm value*

The following message will appear:



4.2 H, ALARM followed by the actual value (the unit is shown by the corresponding LED 4 or 5 on the front panel)

*Display S4.3: Delay (in seconds) of the alarm relay*

The following message will appear:

4.3 ALARM DELAY followed by the actual value.

*Display S6.1: Logic input*

The following message will appear:

6.1 LOGIC INPUT followed by the actual setting (ON/OFF)

*Display S10.1: Password for the set up menu*

The following message will appear:

10.1 SET-UP PASS followed by ---

### 5.3.8 Maintenance of the unit

Quality components are used to give the controller a high reliability.

The frequency of such maintenance depends on the nature of each particular application.

As in any electronic equipment, the mechanical components such as switches, relays and connectors, are the most subject to damage.

### 5.3.9 Maintenance of the sensor

The state of the sensors surface and is critical for the normal operation of the system and should be inspected more frequently when are present oxides, or organic compounds.

Clean the sensor, the flow cell and replace the membrane/electrolyte according to the instruction of the specific sensor.



## 5.4 INSTRUCTIONS FOR THE PLANT ENGINEER

### 5.4.1 Safety instruction



Read the installation instruction (Chapter 6) and check the following before switching on the unit and performing the configuration:

- Check if the terminal 3 is connected to the ground;
- check if the connections are correct;
- check if connections are well fastened to the terminals;
- check if eventual protective fuses have the correct value.

#### WARNINGS

*Eventual damages coming from wrong connections are not covered by warranty.*

### 5.4.2 Configuration



by pressing three times the key from display 1.0, the unit will show the message `ConFI G PrESS Ent` (display 11.0).



By pressing the key the unit will require the password insertion (display 11.1)

`PASS ---`



or , press the key to insert the password



press to confirm the password and to enter the configuration menu (if the password is not used, press again the key ).

Into the configuration menu the keys have the following functions:



or  to change values or options shown on the displayed



to confirm the value/option (if value/option have been modified it will appear the message `UPdAtE`)



to exit from the procedure and to turn to display 11.0 without any changing.



*Display C1.1: Type of sensor selection*

The following message will appear:

**1.1 CELL POLE/POLA** followed by the actual setting

*Display C1.2: Full scale selection*

The following message will appear:

**1.2 SCALE** followed by the actual setting

*Display 1.3: Measuring unit selection*

The following message will appear:

**1.3 MEAS. UNIT** followed by the actual setting

*Display 1.4: Polarization voltage*

The following message will appear:

**1.4 POL.** followed by the actual setting

*Display C2.1: Type of RTD (Pt100 or Pt1000)*

The following message will appear:

**2.1 TEMP. SENSOR Pt** followed by the actual setting (**100/1000**)

*Display C3.1: Set point 1 function (min/max)*

The following message will appear:

**3.1 SET 1 FUNCT ION** followed by the actual setting (**L0/H 1**)

*Display C3.2: Set point 2 function (min/max)*

The following message will appear:

**3.2 SET 2 FUNCT ION** followed by the actual setting (**L0/H 1**)



*Display C4.1: Alarm relay function (activated/deactivated)*

The following message will appear:

4.1 ALARm Funct ion followed by the actual setting (Act./dEA.)

*Display C5.1: Range of the analog output (0/20 or 4/20 mA)*

The following message will appear:

5.1 out followed by the actual setting (0-20/4-20).

*Display C6.1: Logic contact function (hold/alarm)*

The following message will appear:

6.1 LOG ic InPUt followed by the actual setting (HoLD/ALAR.)

*Display C11.1: Password for the configuration menu*

The following message will appear:

11.1 CONF ig. PASS followed by the actual password ---.



## 6 INSTALLATION

### 6.1 PACKING LIST

The carton box contains:

- N° 1 the instrument with s/n label,
- N° 2 fixing clamp,
- N° 1 instruction manual.

### 6.2 UNPACKING

- 1) Remove the instruction manual.
- 2) Remove the controller from the carton box.
- 3) Remove the plastic protective envelope and keep the two fixing clamp.

### 6.3 STORAGE AND TRANSPORTATION

In case of long storage period, keep the instrument in a dry area.

In case of transportation, use the original carton box.

### 6.4 INSTALLATION OF THE UNIT

The instrument can be installed in a watertight enclosure or in a switch board.

The panel mounting must be done on a flat surface in a position protected from hits, moisture and corrosive fumes.

### 6.5 INSTALLATION OF THE SENSOR

The measuring sensor and the flow cell must be installed properly if the system is to operate accurately and efficiently.

It must meet the following requirements:

- the sample in the cell must be representative of the whole solution
- the solution must circulate continuously through the cell
- sediments must not accumulate within the sensor area

Keep the cable away from power wires on the overall length.

This cable too must not be interrupted on overall length. If interruption is necessary, the extension cable must be fastened to the high insulation terminal strip.



## 6.6 ELECTRICAL INSTALLATION

Refer to figure 2 or to the connections drawing on the back panel of the instrument.

The electrical installation consists of:

- 1) connecting the power supply;
- 2) connecting the electrodes or probes;
- 3) connecting the temperature sensor;
- 4) connecting the set points and alarm relays;
- 5) connecting the analog output;
- 6) connecting the logic input.

All connections to the instrument are made on detachable terminal strips located on the rear side.

The power connections are on a 10 terminals strip.

The signals connections are on a 5 terminals strip.

The analog output and logic input connections are on a 4 terminals strip.

### 6.6.1 Connecting the power



- Connect the ground to 3 terminal.
- Connect the 86/264 Vac power to 1-2 terminals

-----

### **WARNINGS**

-----

- *power the device by means of an isolation transformer*
- *avoid mains voltage from an auto-transformer*
- *avoid mains voltage from a branch point with heavy inductive loads*
- *separate power supply wires from signal ones*
- *control the mains voltage value before powering the unit.*

*The electronic equipment can occasionally be damaged.*

*The plant engineer must consider this event to prevent eventual damages caused by the instrument malfunctioning.*

### 6.6.2 Connecting the sensor

The connection of the electrodes is the most critical of the system.

#### Connecting the polarographic sensor (CL7901 or OZ7901)

Those sensors include the Pt100 and they are provided with a detachable cable with colored wires.

Connect the brown wire (cathode) to the terminal 25 marked IN.

Connect the white wire (anode) to the terminal 23 marked CE or to the terminal 24 marked R.

Connect the red wire (Pt100) to the terminal 27 marked t1.



Connect the black wire (Pt100 common) to the terminal 28 marked t2.  
Connect the green wire (Pt100 common) to the terminal 29 marked t0.

#### Connecting the potentiostatic sensor

The potentiostatic sensor SZ283 is provided with a shielded cable with two colored wires.

Connect the black wire (cathode) to the terminal 25 marked IN.  
Connect the white wire (counter electrode) to the terminal 23 marked CE.  
Connect the shield (reference) to the terminal 24 marked R.

### 6.6.3 Connecting the temperature sensor

In order to display the temperature value and to effect the automatic temperature compensation on the measuring, it is necessary to connect the RTD sensor Pt100 or Pt1000.

The sensors of CL7901 or OZ7901 cell assembly include the Pt100 to be connected as described in the previous chapter.

If the temperature sensor is not connected, interrupted or in a short circuit, the unit will turn to the manual temperature compensation automatically.

#### Two wires connection of Pt1000 or Pt100 for short distance

Use a suitable two wires cable

- Connect the RTD to 27-28 terminals and install a jumper between 28-29 terminals.

The two wires connection of the Pt100 may require the temperature zero calibration to compensate the wires resistance effect.

#### Three wires connection of Pt100 for long distance

Use a suitable three wires cable.

- Connect the RTD lead to 27 terminal.
- Connect the RTD common lead to 28 and 29 terminal by using two separate wires.
- Do not interrupt the cable.  
Use high isolation terminals in case of cable extension.
- Keep the cable away from the power cables.
- In case of interference use a shielded cable and connect the shield to the 3 terminal.

### 6.6.4 Connecting the analog output

The instrument provides an isolated output current, proportional to the main measuring to send to an external recorder, PLC or similar devices.

- Connect (+) terminal of the recorder to the 15 terminal of the unit.



- Connect (-) terminal of the recorder to the 16 terminal of the unit.

If the output current will drive more loads, connect the devices in series.

The total resistance must be lower than 600 Ω.

-----  
**WARNINGS**  
 -----

*Do not supply any voltage to the analog output terminals to avoid damages on the output circuits.  
 Connect only to passive input devices.*

### 6.6.5 Connecting the pumps, solenoids and alarms

The contacts of the control and alarm relays are available on the rear terminal strip of the instrument. The contacts are SPST type corresponding to set point 1 and set point 2 and SPDT type corresponding to the alarm function.

#### SET POINT 1

terminal 5 marked C : common contact

terminal 4 marked NO : normal open contact

#### SET POINT 2

terminal 7 marked C : common contact

terminal 6 marked NO : normal open contact

Power the load through an independent power supply in order to avoid interferences from inductive load. Install snubbers if necessary.

Install fuses as protection of the relays contacts in case of short circuit of the load.

Do not exceed the nominal current rate of the contacts (5 A resistive load).

At this step of the connection remember that each relay can be configured as min/max function.

The set point values can be adjusted only if the calibration has not been disabled; the delay can be adjusted in the set up menu. (see chapters 5.3.5, 5.3.7).

To modify the function min/max (Lo/Hi) of the set points see the charter 5.4.2.

#### ALARM

terminal 9 marked C : common contact

terminal 8 marked NO : normal open contact

terminal 10 marked NC : normal closed contact

The alarm relay can be configured as activated/deactivated (Act/Dea) during the alarm conditions of the measuring.

The alarm condition occurs when the measuring is lower/higher than min/max selected values (see chapter 5.3.7); the delay of the relay action can be selected (see chapter 5.4.2).



If the configuration “Deactivated” (**dER**) is selected, the relay will provide the alarm contact even when the unit is switched off or the it is not in operation.

### 6.6.6 Connecting the logic input

The dry contacts (voltage free) coming from an external device must be connected to the logic input terminals 17 – 18.

The activation and the configuration of the input logic is described in the Display S6.1 (chapter 5.3.7) and C6.1 (chapter 5.4.2).

The hold or alarm functions are described in the item 6.0 of the chapter 4.2 “Technical specifications”.

-----  
**WARNINGS**  
-----

*Do not supply any voltage to the logic input terminals to avoid damages on the circuits.*

## 7 DISPOSAL

If it shall became necessary to throw away this electronic equipment, please follow the disposal laws of your Country.



REAR PANEL CONNECTIONS  
CL3040 (CL 7635)

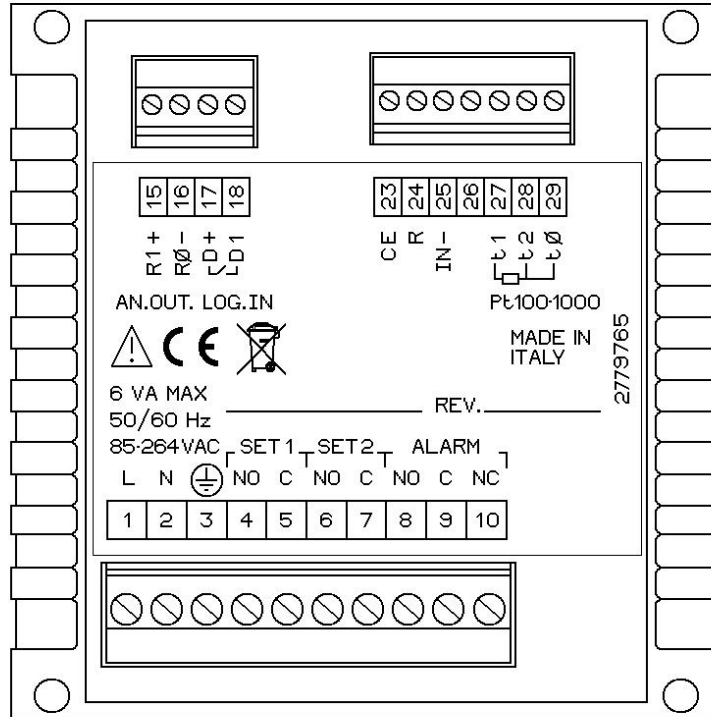

- 1. 2            Power supply 85-264 Vac
- 3.             Ground
- 4. 5           Set point 1 N. O. contacts
- 6. 7           Set point 2 N. O. contacts
- 8. 9           Alarm N.O. contacts
- 9. 10          Alarm N.C. contacts
- 15.           Analog output (+)
- 16.           Analog output (-)
- 17. 18          Logic input
- 23.           Counter electrode input (anode)
- 24.           Reference electrode input
- 25.           Measuring electrode input (cathode)
- 27. 28. 29    RTD Pt100/Pt1000 input

Fig. 2





DIMENSIONS

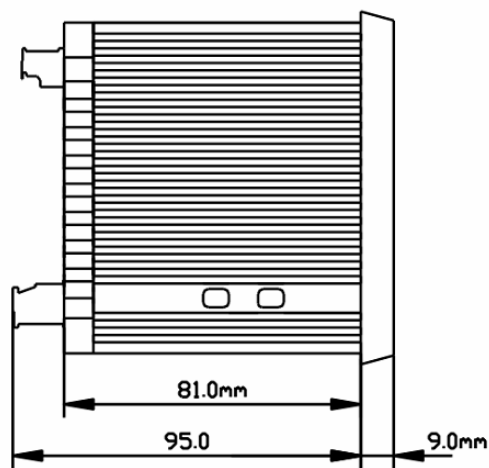
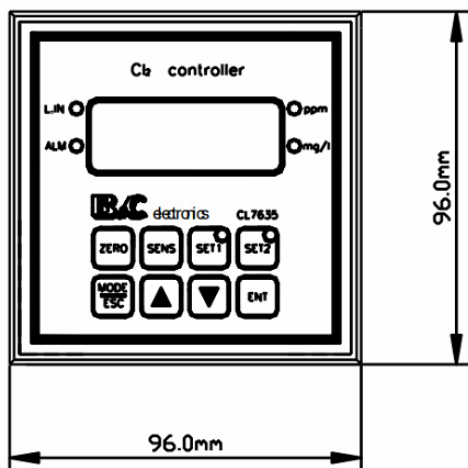

DRILL PLAN

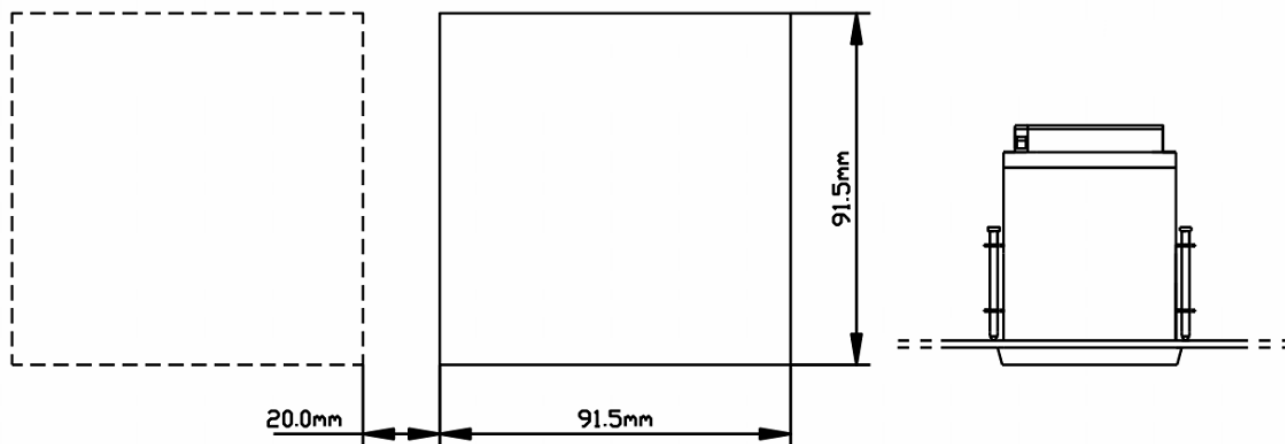

Fig. 3



---

## WARRANTY CERTIFICATE

- 1) Your product is covered by Nieuwkoop/B&C Warranty for 5 years from the date of shipment. In order for this Warranty to be valid, the Manufacturer must determine that the instrument failed due to defective materials or workmanship.
  - 2) The Warranty is void if the product has been subject to misuse and abuse, or if the damage is caused by a faulty installation or maintenance.
  - 3) The Warranty includes the repair of the instrument at no charge. All repairs will be completed at the Manufacturer's facilities in Aalsmeer, The Netherlands.
  - 4) Nieuwkoop/B&C assumes no liability for consequential damages of any kind, and the buyer by accepting this equipment will assume all liability for the consequences of its use by the Customer, his employees, or others.
- 

## REPAIRS

- 1) In order to efficiently solve your problem, we suggest You to ship the instrument along with the Technical Support's Data Sheet (following page) and a Repair Order.
- 2) The estimate, if requested by the Customer, is free of charge when it is followed by the Customer confirmation for repair. As opposite, if the Customer shall not decide to have the instrument repaired, he will be charged to cover labor and other expenses needed.
- 3) All instruments that need to be repaired must be shipped pre-paid to Nieuwkoop B.V. All other expenses that have not been previously discussed will be charged to Customer.
- 4) Our Sales Dept. will contact You to inform You about the estimate or to offer you an alternative, in particular when:
  - the repairing cost is too high compared to the cost of a new instrument,
  - the repairing results being technically impossible or unreliable
- 5) In order to quickly return the repaired instrument, unless differently required by the Customer, the shipment will be freight collect and through the Customer's usual forwarder.



# TECHNICAL SUPPORT

## *Data sheet*

In case of damage, we suggest You to contact our Technical Support by email or phone. If it is necessary for the instrument to be repaired, we recommend to photocopy and fill out this data sheet to be sent along with the instrument, so to help us identifying the problem and therefore accelerate the repairing process.

**ESTIMATE**

**REPAIR**

-----  
COMPANY NAME

-----  
ADDRESS

ZIP

CITY

-----  
REFER TO MR./MISS.

PHONE

-----  
MODEL

S/N

DATE

-----  
Please check the operator's manual to better identify the area where the problem seems to be and please provide a brief description of the damage:

SENSOR

ANALOG OUTPUT

POWER SUPPLY

SET POINT

CALIBRATION

RELAY CONTACTS

DISPLAY

PERIODICAL MALFUNCTIONING

➤ **DESCRIPTION**

.....  
.....  
.....  
.....  
.....  
.....  
.....  
.....



TO MEASURE  TO KNOW

**Nieuwkoop BV**

Aalsmeerderweg 249 -S

1432 CM AALSMEER

0297 325836

[info@nieuwkoopbv.nl](mailto:info@nieuwkoopbv.nl)

[www.meten.nl](http://www.meten.nl)



**NIEUWKOOP**