



NIEUWKOOP

USER MANUAL



DP3000

PH DOSING PUMP



TO MEASURE  TO KNOW



GENERAL WARNING

GENERAL PRESCRIPTIONS

We would like to thank you for choosing this product, it is recommended to read the handbook carefully, before proceeding to the installation of the dosing pump, lend particular attention to the warnings of emergency marked from graphic symbol.

The respect of the norms and the prescription reported can assure a safe and appropriate participation. The handbook and maintenance constitute an integral part of the machine and it must be available to the assigned staff for its use and maintenance, therefore it is necessary to conserve it integrate in a safety place.

TECHNICAL ASSISTANCE

The ordinary and extraordinary maintenance must be in agreement to the instructions in the present handbook. For all the cases and every kind of assistance we recommend to contact directly the constructor by referencing to data sheet inserted in the pump's label.

- **Model of the pump.**
- **Serial number**
- **Year of construction.**

In case the maintenance of the pump is executed in an unconformable way to the supplied instructions, or can prejudice the integrity or modify the characteristics, the constructor will be considered relieve from whichever responsibility inherent to the security of the persons and the defective operation of the pump. For every kind of technical assistance and demands for replacement parts it is recommended to contact the headquarter.

Nieuwkoop BV P.O. BOX 78 – 1430 AB Aalsmeer

Commercial Department: Ph. +31 297 325836 – fax +31 297 323167

Web: www.meten.nl

E-mail: info@nieuwkoopbv.nl

RESPONSIBILITY

The lack of respect of the instructions included in the handbook and the maintenance will exempt the constructor from whichever responsibility.

For any data sheet that it is not included and not deducible from the pages to follow, we recommend to consult directly the constructor.

INFORMATION TO THE CONSUMERS

To the Senses Of the article 13 and the legislative decree of July 25 2005, n 151 " realization directives 2002/95/CE, 2002/96/CE, 2003/108/CE related to the reduction of the use of dangerous substances in the electric equipments and electronics, as well as to the disposal of the refusals.



The symbol "cross chest" brought on the equipment points out that the product at the end of its function cannot be digested as normal urban refusal.

The consumer must confer the equipment to the fit centers of diversified harvest of the electric and electronic refusals, or to redeliver it to the retailer during the purchase of a new equipment.



The suitable diversified harvest contributes to avoid possible negative effects on the environment and on the health and favors the retrain of the materials of which the equipment is composed.

The unauthorized disposal from the consumer involves the application of the administrative sanctions of which "article 50 and following of the D. Lgs. n. 22/1977."



CONFORMITY DECLARATION

DECLARES:

That **THE ELECTROMAGNETIC PUMPS**
SDP Series
Type **SMF – SMF-R**

They have been planned and realized in the following conformities with directions and specifications

Electromagnetic compatibility CEM 89/336/CEE
Low voltage n. 73/23/CEE with modification n. 93/68/CEE

Cologno Monzese,

Signed by: **MICCICHE' TULLIO**
Charged by: Responsible of quality



INDEX

1	HINTS AND WARNINGS	6
1.1	WARNINGS.....	6
1.2	SHIPPING AND TRANSPORTING THE PUMP.....	6
1.3	PROPER USE OF THE PUMP.....	6
1.4	RISKS.....	6
1.5	TOXIC OR DANGEROUS LIQUID DOSAGE.....	7
1.6	ASSEMBLING AND DISASSEMBLY THE PUMP.....	7
1.6.1	ASSEMBLY.....	7
1.6.2	DISASSEMBLY.....	7
2	METERING PUMPS series SDP type SMF – SMF-R	8
2.1	OPERATION.....	8
2.2	TECHNICAL SPECIFICATIONS.....	8
2.3	LIQUID ENDS MATERIALS.....	9
3	INSTALLATION	9
3.1	INJECTION VALVE INSTALLATION.....	11
3.2	MANUAL STROKE LENGTH ADJUSTMENT.....	11
3.3	WIRING CONNECTION AND OUTPUT CONNECTOR FUNCTIONS.....	12
3.4	INPUT/OUTPUT EXTERNAL CONNECTIONS (FOR EXTERNAL ACCESSORY).....	12
3.5	SUMMARY OF TYPE OF CONNECTIONS.....	12
4	MAINTENANCE	12
5	HOW TO OPERATE WHEN DOSING SULPHURIC ACID	13
6	MICROCONTROLLED METERING PUMP WITH PH-RX-CL CONTROLLER	13
6.1	PUMP CONTROLS.....	13
6.2	ACCESSORIES.....	14
6.3	TYPICAL INSTALLATION.....	14
6.4	LEVEL CONTROL.....	14
6.5	DISPLAY DESCRIPTION.....	15
6.6	TYPICAL CHARACTERISTICS.....	16
6.7	PARAMETERS AND FUNCTIONS LAYOUT.....	16
7	PROGRAMMING	17
7.1	PUMP SETUP.....	17
7.1.1	MEASURE TYPE SELECTION.....	18
7.1.2	PASSWORD.....	18
7.1.3	CHOICE OF INPUT LEVEL/FLOW.....	18
7.1.4	TEMPERATURE SELECTION BETWEEN CELSIUS AND FAHRENHEIT DEGREES.....	18
7.1.5	CALIBRATION EXIT DELAY.....	18
7.1.6	SWITCHING-ON DELAY.....	18
7.2	MEASURING CALIBRATION.....	19



7.3	SETPOINT SETTING.....	19
7.3.1	SETPOINT VALUE.....	20
7.3.2	DIRECTION MENU.....	20
7.3.3	MANUAL OR PROPORTIONAL MODE.....	20
7.3.4	FREQUENCY ADJUSTMENT.....	21
7.3.5	MAX FREQUENCY ADJUSTMENT.....	21
7.3.6	HYSTERESIS MENU.....	21
7.3.7	4 – 20 mA CALIBRATION.....	22
7.4	ALARM SETTINGS.....	22
7.4.1	MAXIMUM ALARM SETTING.....	22
7.4.2	MINIMUM ALARM SETTING.....	22
7.4.3	OVERDOSING ALARM SETTING.....	23
7.5	RESET PROCEDURE.....	23
7.5.1	PARTIAL RESET PROCEDURE.....	23
7.5.2	TOTAL RESET PROCEDURE.....	23
7.6	STANDY-BY PROCEDURE.....	23
8	TROUBLE SHOOTING COMMON TO SDP series PUMPS.....	24
8.1	MECHANICAL FAULTS.....	24
8.2	ELECTRICAL FAULTS.....	24
	DRAWINGS AND DETAILS.....	25



1 HINTS AND WARNINGS

1.1 WARNINGS

Please read the warning notices given in this section very carefully, because they provide important information regarding safety in installation, use and maintenance of the pump.

N.B. The pump has been constructed in accordance with best practice. Both its life and its electrical and mechanical reliability will be enhanced if it is correctly used and subjected to regular maintenance.

ATTENTION!

Any intervention or repair to the internal parts of the pump must be carried out by qualified and authorized personnel. The manufacturer declines all responsibility for the consequences of failure to respect this rule.

GUARANTEE!

1 year (the normal wearing parts are excluded, i.e.: valves, nipples, tube nuts, tubing, filter and injection valve. Improper use of the equipment invalidates the above guarantee. The guarantee is ex factory or authorized distributors.

1.2 SHIPPING AND TRANSPORTING THE PUMP

The pump should always be moved in a vertical position and never in a horizontal position. The shipment with whichever forwarder is done, even if it is (CPT) carried paid to the address of the purchaser or addressee, one agrees carried out to risk and danger of the purchaser. Claims for any missing materials must be made within 10 (ten) days of the arrival, while claims for defective materials will be considered up to the 30th (thirtieth) day following receipt. Return of pumps or other materials to us or the authorized distributor must be agreed beforehand with the responsible personnel.

1.3 PROPER USE OF THE PUMP

The pump should be used only for the purpose for which it has been expressly designed, namely the dosing liquid additives. Any different use is to be considered improper and therefore dangerous. The pump should not therefore be used for applications that were not allowed for in its design. In case of doubt, please contact our offices for further information about the characteristics of the pump and its proper use.

The manufacturer cannot be held responsible for damage deriving from improper, erroneous or unreasonable use of the pump.

1.4 RISKS

- After unpacking the pump, make sure it is completely sound. In case of doubt, do not use the pump and contact qualified personnel. The packing materials (especially bags made of plastics, polystyrene, etc.) should be kept out of the reach of children: they constitute potential sources of danger.
- Before you connect the pump, make sure that the voltage ratings, etc correspond to your particular power supply. You will find these values on the rating plate attached to the pump.
- The electrical installation to which the pump is connected must comply with standards and good practice rule in force in the country under consideration.

Use electrical equipment always implies observance of some basic rules. In particular:

- ✓ Do not touch the equipment with wet or damp hands or feet.
- ✓ Do not operate the pump with bare feet (example: swimming pool equipment).
- ✓ Do not leave the equipment exposed to the action of the atmospheric agents.
- ✓ Do not allow the pump to be used by children or unskilled individuals without supervision.



In case of breakdown or improper functioning of the pump, switch off; but do not touch. Contact our technical assistance for any necessary repairs and insist on the use of original spares. Failure to respect this condition could render the pump unsafe for use.

When you decide to make no further use of an installed pump, make sure to disconnect it from the power supply.

ATTENTION!

Before carrying out any service on the item, check:

- 1 Disconnect the pins from the mains or by means of a two poles switch with 3 mm minimum distance between the contacts (Dwg. 4).
- 2 Relieve all the pressure from the pump head and injection tube.
- 3 Drain or flush all dosing liquid from the pump head. This operation can also be done with the pump disconnected from the plant by turning the pump upside-down for 15 to 30 seconds and without connecting the tubing to the nipples: if this operation is not possible, dismount and remount the pump head using the four mounting screws (Dwg. 10).

In event of possible losses in the hydraulic system of the pump (breakage of the "O" ring gasket, the valves or the hoses) the pump should immediately be brought to a stop, emptying and depressurising the delivery hose while taking all due safety precautions (gloves, goggles, overalls, etc).

1.5 TOXIC DANGEROUS LIQUID DOSAGE

To avoid risk from contact with the hazardous liquids or toxic fumes, always adhere to the notes in this instruction manual:

Follow the instructions of the dosing liquid manufacturer.

Check the hydraulic part of the pump and use it only if it is in perfect condition.

Use only the correct materials for the tubing, valves and seals to suit the liquid to be dosed; where possible shield the tubing with PVC conduit.

Before disconnecting the metering pump, make sure to flush out and neutralize the pump head with the proper reagent liquid.

1.6 ASSEMBLING AND DISMANTLING THE PUMP

1.6.1 ASSEMBLY

All metering pumps are normally supplied fully assembled. For greater clarity, please consult the exploded view of the pump appended at the end of the manual, which shows all the pump details and a complete overview of all the pump components. These drawings are in any case quite indispensable whenever defective parts have to be re-ordered. For the same purpose, the appendix also contains other drawings showing the hydraulic parts (pump head and valves).

1.6.2 DISASSEMBLY

Proceed as follow before you dismantle the pump or before performing any other operation on it:

- ✓ Disconnect the pins from the mains or by means of a two poles switch with 3mm minimum distance between the contacts (Dwg. 4).
- ✓ Relieve all the pressure from the pump head and injection tube.
- ✓ Drain or flush all dosing liquid from the pump head. This operation can also be done with the pump disconnected from the plant by turning the pump upside-down for 15 to 30 seconds and without connecting the tubing to the nipples: if this operation is not possible, dismount and remount the pump head using the four mounting screws (Dwg. 10).
- ✓ This operation calls for special attention, and you should therefore consult the drawing in Appendix and Chapter **1.4 "RISKS"** before you commence work.

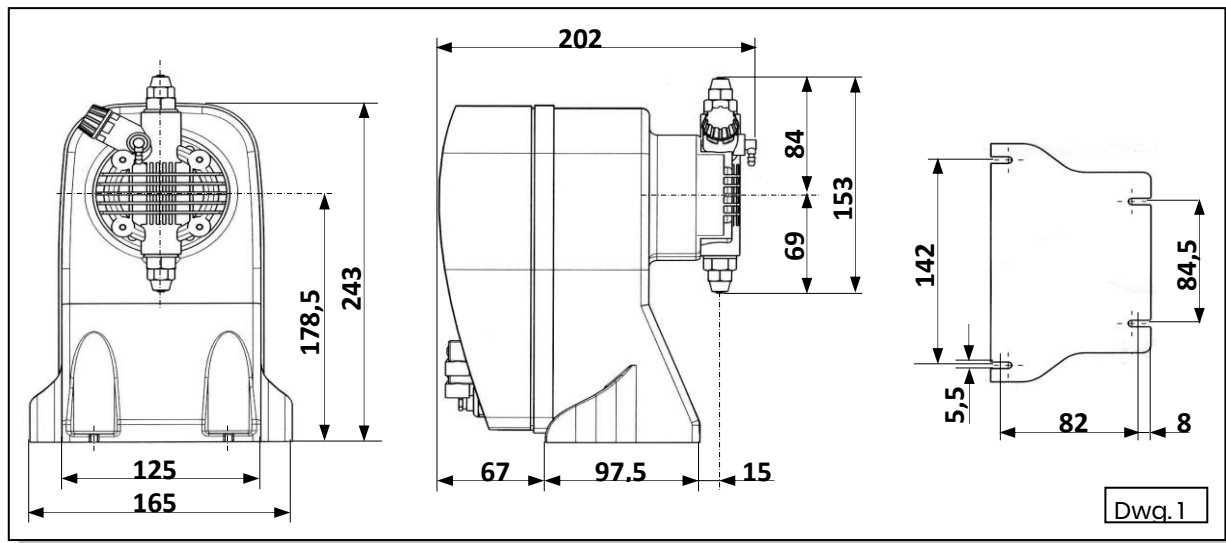

2 METERING PUMPS SDP series, SMF – SMF-R type

2.1 OPERATION

The metering pump is activated by a PTFE diaphragm mounted on a piston of an electromagnet. When the piston of the electromagnet is attracted, a pressure is produced in the pump body with an expulsion of liquid from the discharge valve. Once the electric impulse is finished a spring brings the piston back to the initial position, with a recall of liquid through the suction valve.

The operation is simple the pump does not need lubrication, therefore maintenance is reduced almost to zero. The materials used for the construction of the pump make it particularly suitable for aggressive liquids.

The metering pump has been designed to feed liquids with capacities from 0 to 20 l/h and pressures from 0 to 20 bar (depending on the model selected).

2.2 TECHNICAL SPECIFICATIONS

- ✓ The products are manufactured according **CE** regulation.
- ✓ Antiacid plastic casing.
- ✓ Control panel protection assured by an adhesive polyester film, weatherproof and resisting UV ray.
- ✓ Standard power supply (fluctuations not to exceed $\pm 10\%$): 230V a.c. 50Hz single phase.
- ✓ Optional power supply (fluctuations not to exceed $\pm 10\%$): 240V a.c. 50-60Hz single phase.
110V a.c. 50-60Hz single phase.
24V a.c., 24V d.c., 12 V d.c.
- ✓ Over voltage cat. II
- ✓ Environmental Conditions: IP65 protection, altitude up to 2000m, ambient temperature 5°C to 40°C, maximum.
- ✓ Relative humidity 80% for temperatures up to 31°C decreasing linearly 50% relative humidity at 40°C
- ✓ Pollution degree 2
- ✓ Upon request: manual stroke length adjustment. This control provides accurate flow adjustment (only **SMF** and **SMF-R**).



2.3 LIQUID ENS MATERIALS

- DIAPHRAGM: PTFE
- PUMP HEAD: Polypropylene, upon request; PVC, S.S. 316 , PTFE, PVDF
- NIPPLES: Polypropylene
- FILTER: Polypropylene
- INJECTION NIPPLE: Polypropylene
- SUCTION HOSE: PVC flexible
- DISCHARGE HOSE: Polyethylene
- VALVES: "lip type": FPM, (upon request available in EPDM end NBR, SILYCON
- 9 VALVES: upon request type in SS 316, Glass Pyrex, ceramic
- 10 SEALS: FPM upon request EPDM, NBR, SILYCON, PTFE.

Technical data pumps SMF – SMF-R Type										
TYPE	Max flow	Output/stroke	Max press.	Stroke	Impulse n°	Power comp.	Corrent comp.	Connections	Suction height	Weight
	l/h	ml/imp.	bar	mm	Imp./min	Watt	Ampere	Øe / Øi	m.c.l.	kg
115	1	0,14	15	0,8	120	37	0,16	06/04	2	2,3
	2	0,28	10							
	3	0,42	5							
	5	0,69	2							
210	2	0,28	10	0,8	120	37	0,16	06/04	2	2,3
	3	0,42	7							
	5	0,69	4							
	7	0,97	2							
507	2	0,28	20	1	120	37	0,16	06/04	2	2,3
	3	0,42	10							
	4	0,56	5							
	5	0,69	3							
	5	0,69	7							
512	7	0,97	4	1	120	58	0,25	06/04	2	2,9
	8	1,11	2							
	5	0,69	12							
	7	0,97	5							
	10	1,39	2							
810	8	1,11	10	1,4	120	58	0,25	06/04	2	2,9
	10	1,39	5							
	13	1,81	2							
	15	2,08	4							
203	16	2,22	2	2,2	120	58	0,25	06/04	2	2,9
	17	2,36	1							
	20	2,78	3							
220	2	0,28	10	1,0	120	58	0,25	06/04	2	2,9
	3	0,42	5							
	5	0,69	2							

The indicated capacity value is subject to change due to the working pressure, the dosed liquid and the viscosity.

3 INSTALLATION

- A Install the pump in a dry place and well away from sources of heat and, in any case, at environmental temperatures not exceeding 40°C. The minimum operating temperature depends on the liquid to be pumped, bearing in mind that it must always remain in a liquid state.



B Carefully observe the regulations in force in the various countries as regards electrical installations (Dwg. 4). When the supply cable is devoid of a plug, the equipment should be connected to the supply mains by means of a single-pole circuit breaker having a minimum distance of 3 mm between the contacts. Before accessing any of the electrical parts, make sure that all the supply circuits are open.

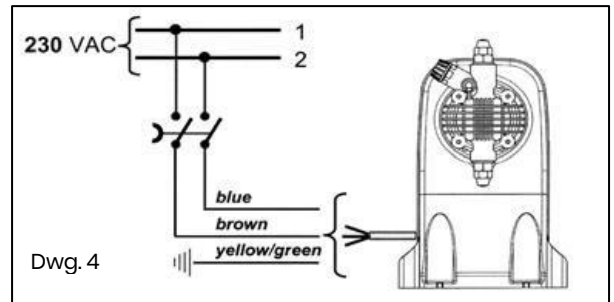

C Locate the pump as shown in (Dwg. 5) bearing in mind that it may be installed either below or above the level of the liquid to be dosed, though the level difference should not exceed 2 meters. When the process plant in which the pump is installed is operating at atmospheric pressure (no back pressure) and the chemical tank situated above the plant (Dwg. 6) the condition of the injection valve should be checked at regular intervals, because excessive wear and tear could cause additive to drip into the plant even when the pump is shut down. If the problem persists, install a properly calibrate counter-pressure valve (C) between injection point and the valve. In the case of the liquids that generate aggressive vapors, do not install the pump above the storage tank unless the latter is hermetically sealed.

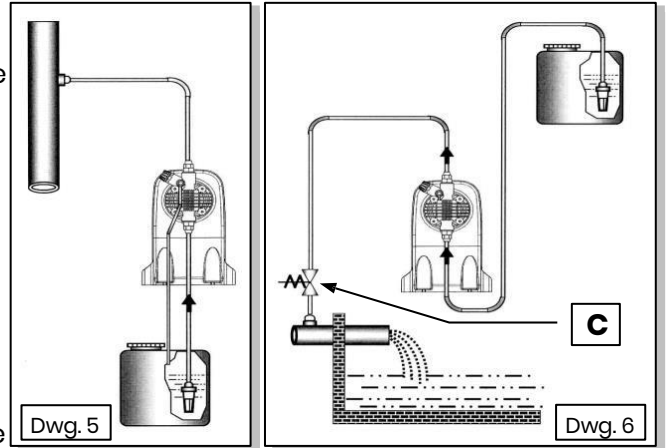

D The discharge nipple will always remain in the upper part of the pump. The suction nipple, which serves to attach the hose (with filter) leading into the chemical tank, will therefore always be situated in the lower part of the pump.

E Remove the protection caps from the two nipples, slide the hoses over the connectors, pushing them right home, and then fix them with appropriate tube nuts (Dwg. 7).

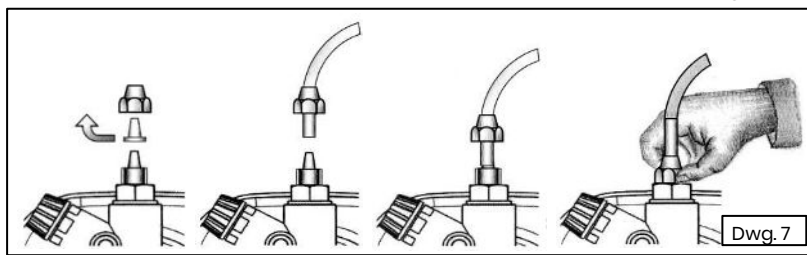

F Whenever the pump is dismantled from the pipework, you will be well advised to replace the caps on the connectors to avoid residual liquid being spilled. Before attaching the delivery hose to the plant, prime the metering pump by going through the sequences shown in (Dwg. 8). Before finalizing the installations of the discharge hose, make sure that the pump strokes will not cause it to move and bump into rigid bodies. In case of priming difficulties, use a normal syringe to suck liquid from the discharge nipple while the pump is in operation, continuing until you actually see the liquid rise in the syringe.

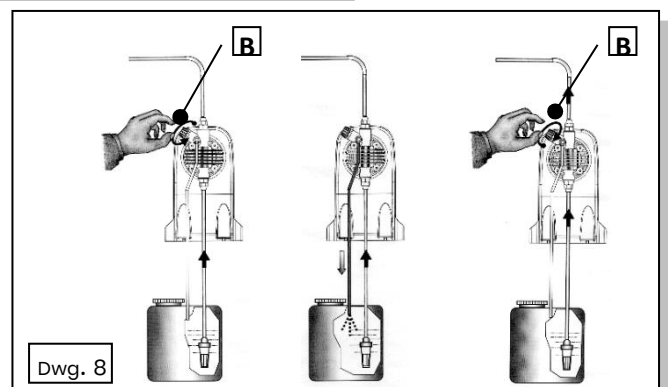



Use a short length of suction hose to connect the syringe to the discharge nipple. In case of a pump equipped with an air bleed valve, unscrew the air relief valve B up to all the air in the pump head will be out.

- G Try to keep both the suction and discharge hose as straight as possible, avoiding all unnecessary bends.
- H Select the most appropriate injection point on a pipe of the plant to be treated and there fit a 3/8" female steel gas thread connector (similar to BSPm) This connector is not supplied with the pump. Screw the injection valve to the gas connector, inserting a gasket as shown in (Dwg. 9). Then connect the discharge hose to the conical connector on the injection valve and fix it with the supplied tube nut **G**. The injection valve also acts as no return valve by means of a cylinder sleeve (elastomer, standard supplied in Viton).

3.1 INJECTION VALVE INSTALLATION

- A Pipework
- C Injection valve
- D Cylinder sleeve (no return valve)
- M Conical connector for attaching the discharge hose
- N 3/8" female steel gas thread connector
- G Hose tube nut
- T Polyethylene hose

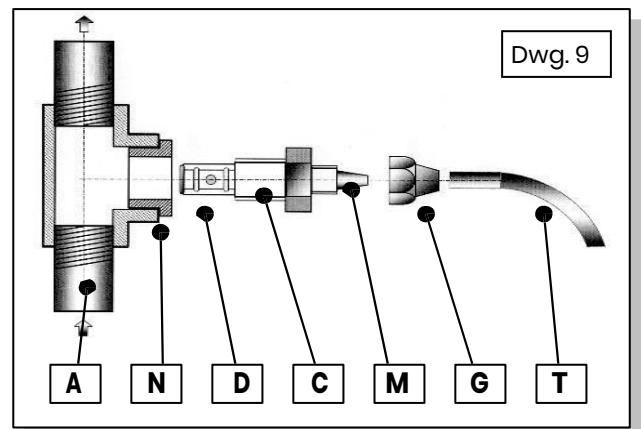

N.B. The sleeve D must not be removed

3.2 MANUAL STROKE LENGTH ADJUSTMENT (upon request only for SMF and SMF-R)

Press and turn the knob (1) up to the stroke length adjustment required

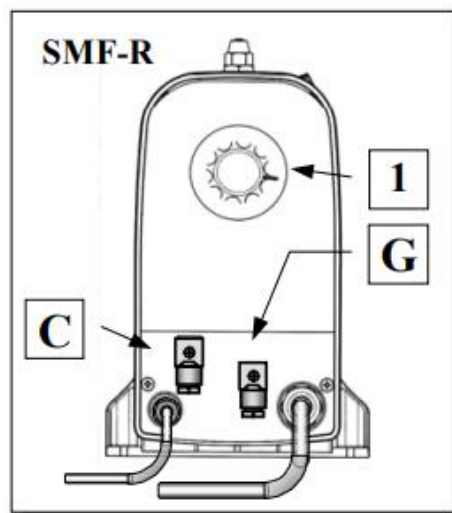
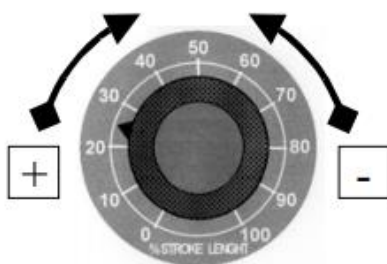



3.3 Wiring connection and output connector functions

INSTRUMENT TYPE	WIRING CONNECTOR	
<p>Level/proximity mA output (G)</p>		<p>Pin 1 - mA output (+) Pin 2 - mA output (-) Pin 3 - level probe/proximity Pin 0 - level probe/proximity (+)</p>
<p>Chlorine probe (C)</p>		<p>Pin 1 No connection Pin 2 No connection Pin 3 Power probe (+5V) Pin 0 Power probe (-5V)</p>

3.4 Input/output external connections (for external accessory)

As shows on paragraph 3.3 the two connectors are used for connecting the level control switch and the mA output signal. It is very important to disconnect the power from the pump when connecting the accessories. It is also very important to protect the unutilized connectors with male connectors supplied with the pump. Such operation will protect the internal circuitry from unwanted shorts and/or the power surge either from the operator or from different sources. **There will be no accessible contacts after installation is completed.** It is imperative that the accessories will be supplied by the factory to avoid unwanted mismatched situations and/or further possible damage (which in this case will be no covered by the warranty). Further more cables and accessories must be suitable and rated for the proper voltage and type of insulation.

3.5 SUMMARY OF TYPE OF CONNECTIONS:

- 1 INPUT LEVEL SWITCH: as shown on paragraph 3.3. the pins (3 e 0) from position (G) are dedicated to the operation of the level sensor. Such operation is activated by a float containing one magnet if the magnet if the liquid is bellow the position or completely absent the flow will slide down activating a reed switch.
- 2 OUTPUT mA SIGNAL: an mA signal that can be used to connect a pH or Rx recorder is available on pins (3 +) and (0 -) of the connector in position (S) (see paragraph 3.3)

4 MAINTENANCE

- 1 Periodically check the chemical tank level to avoid the pump operating without liquid. This would not damage the pump, but may damage the process plant due to lack of chemicals.
- 2 Check the pump operation condition at least every 6 months, pump head position, screws, bolts and seals; check more frequently where aggressive chemicals are pumped, especially:

Pulse and power L.E.D

The additive concentration in the pipework; a reduction of this concentration could be caused by the wearing of the valves, in which case they need to be replaced (Dwg. 10) or by the clogging of the filter which then has to be cleaned as in point 3 here below.

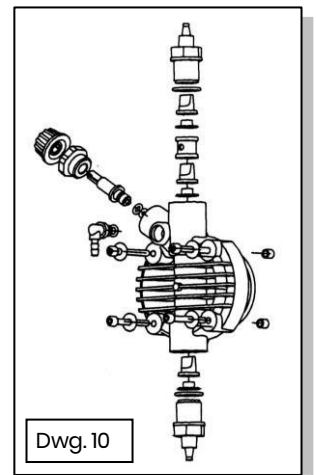



- 3 The company suggests periodically cleaning of the hydraulic parts (valves and filter). We cannot say how often this cleaning should be done as it depends on the type of application, we also cannot suggest what cleaning agent to use as this will depend on the additive used.

Operating suggestions when dosing sodium hypochlorite (most frequent case):

- A Disconnect the pins from the mains or by means of a omnipolar switch with 3 mm minimum distance between the contact.
- B Disconnect discharge hose from pipework.
- C Remove the suction hose (with filter) from the tank and dip it into clean water.
- D Switch on the metering pump and let it operate with water for 5 to 10 minutes.
- E Switch OFF the pump, dip the filter into a hydrochloric acid solution and wait until the acid finishes cleaning.
- F Switch ON the pump again and operate it with hydrochloric acid for 5 minutes in a closed circuit, with suction and discharge hose-dipped into the same tank.
- G Repeat the operation with water.
- H Re-connect the metering pump to the pipework.

5 HOW TO OPERATE WHEN DOSING SULFURIC ACID (MAX 50%)

In this case it is essential to remember the following:

- 1 Replace PVC crystal suction hose with polyethylene discharge hose.
- 2 Empty any residual water from the pump head before use.

Warning: if the water mixes with sulfuric acid it can produce a large quantity of gas with consequent overheating of the area causing damage to valves and pump head.

This operation can also be done with the pump disconnected from the plant by turning the pump upsidedown for 15 to 30 seconds and without connecting the hose to the nipples; if impossible, dismount and remount the pump head (Dwg. 10) using the four mounting screws.

6 MICROCONTROLLED METERING PUMP WITH PH-RX-CL CONTROLLER

This unit is dosing pump with integral pH-RX-ppm Cl controller designed to measure, control and regulate the several values. The pump works on an ON/OFF system controlled by a microcontroller to stop dosing once the pH value reaches set point. Measuring range: 0 / 14 pH (resolution 0,01 pH).

6.1 PUMP CONTROLS

- 1 Confirm functions/values button
- 2 Increasing values button
- 3 Cursor movement button
- 4 Decreasing values button
- 5 Exit menu button
- 6 Yellow LED level alarm
- 7 Red LED injection pulse
- 8 Green LED power supply
- 9 LCD display

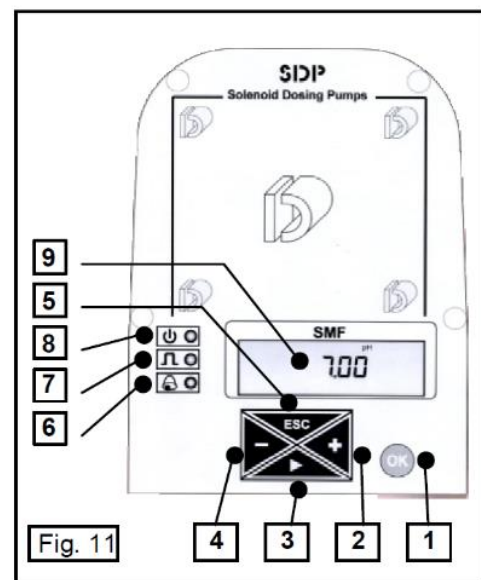



6.2 ACCESSORIES

- 1 N°1- Flexible PVC suction hose transparent crystal type, length 2 m.
- 2 N°1- Semirigid polyethylene hose, white, length 2 m.
- 3 N°1- injection valve 3/8 BSP m.
- 4 N°1- Filter
- 5 N°1- Instructions/operating booklet.

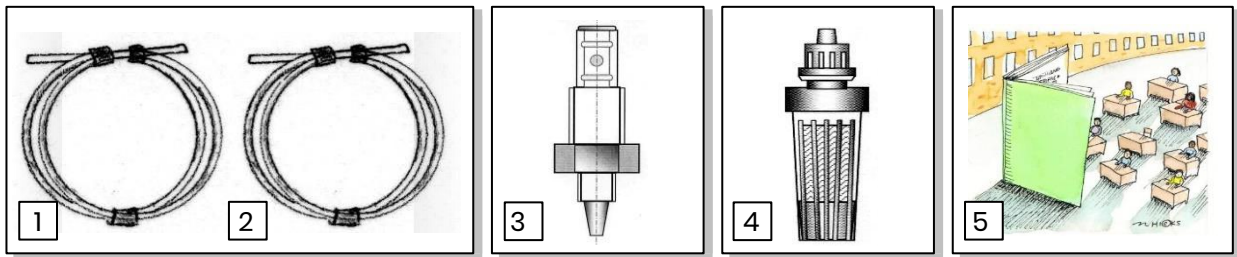

6.3 TYPICAL INSTALLATION

- A Injection valve
- B Power supply
- C Filter
- D Level switch
- E Electrode
- I Chemical tank
- P Electrode holder
- V Process tank

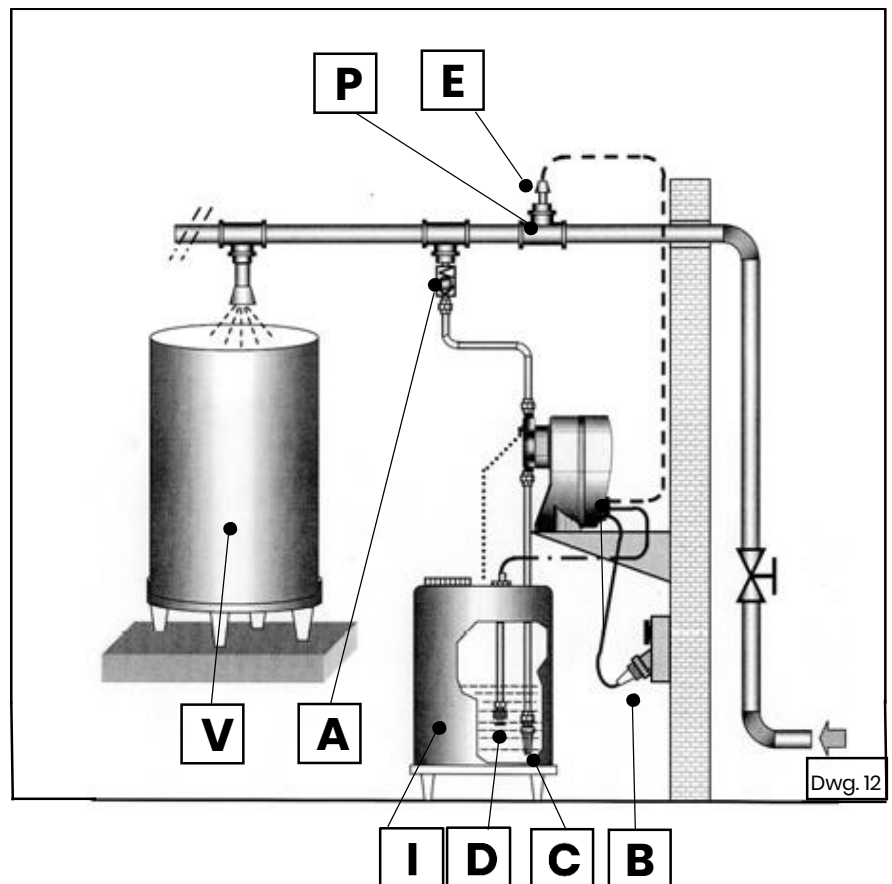

6.4 LEVEL CONTROL

The dosing pump is supplied with level control setting and upon request floating level switch. When the level of the additive is lower than the switch, level alarm and yellow led are ON: the pump is OFF. The level control alarm goes ON with 5 seconds delay.



6.5 DISPLAY DESCRIPTION



OVER	Overdosing alarm
DDELAY	Delay at powering on
SETPOINT	Setpoint setting
LEVEL	Level alarm
ALARM	Alarms setting
MENU	Menu selection
ON-OFF	ON-OFF functioning mode
PROP	Proportional functioning mode
PT100	Temperature probe
HYST	Hysteresis setting
12	Calibration points
CALIB.	Calibration menu
SETUP	General instrument settings
STARTUP	Switching-on delay settings
INPUT MODE	Level probe/flow sensor input activation
RESET	Reset activation
DIRECTION	Intervention selection
MAX	Maximum pulses frequency based to maximum measuring value
4 20 mA	Output current settings
h:m:s	Hours:minutes:seconds
°C	Temperature measurement unit in Celsius
°F	Temperature measurement unit in Fahrenheit
%	Flow rate percentage
mV Rx	mV measure
pH	pH measure
Cl ppm	ppm Cl measure
	Password setting
	Intervention Alkaline/Oxidant/Direct
	Intervention Acid/Reductive/Inverse
	Pulses/minute
	Flow sensor
	Numeric values visualization



6.6 TYPICAL CHARACTERISTICS

FUNCTIONS	VALUE
Temperature	0÷+40°C
Max current relay output	6A (resistive load) 1A (inductive load)
Corrent output	4 - 20 mA (dynamic 0...500 ohm)
pH measure	0÷14 (resolution 0,01 pH)
RX (mV) misure	-1.000÷+1.400 (resolution ±1 mV)
Chlorine measure	0÷2; 0÷20; 2÷200; 0÷2000 (0,1 ppm)
Temperature measure (Pt100)	0÷+100°C (resolution 0,1°C)

6.7 PARAMETERS AND FUNCTIONS LAYOUT (Factory default-pH)

FUNCTIONS	DEFAULT
Setpoint setting	7,2
Hysteresis setting	0,1
Choice of the type of intervention	Acid
Manual or proportional intervention selection	Manual
Definition of beginning intervention value "AUTO"	Setpoint + 1pH
First point of calibration procedure	-----
Second point of calibration procedure	-----
Minimum alarm point	0,00
Maximum alarm point	14.00
Over-dosing alarm value	99:59 h:m
Choice of the type of menu: BASIC and FUL (expert user)	Basic
Selection measures to control (pH, RX or Chlorine)	pH
Six figures numerical password	Esclusa
Chosen thermal selection (°C or °F)	°C
Temperature compensation selection (manual - auto)	Manual - 25°C
Delay at powering on	00:03 m:s
Delay exit calibration menu	05:00 m:s
Calibration check	4 mA
Calibration check	20 mA



7.0 PROGRAMMING

Through the front panel it is possible to set and to modify all the working parameters of operating setting of the pump.

7.1 PUMP SETUP

The first operation to do is to select the type of parameter (pH, Redox or free Chlorine) that is intends to measure and to control.

The pump has turned on, on display it appear software revision then the type of controlled parameter that it flashes (default settings: pH - menu BASE).

In this phase it is possible to set measure type by means on the (+ and -) buttons and to confirm through the OK button.

After confirm with the OK button the measure's type, the pump goes in measure mode, on display will show the measure's value.

Press OK button to enter in menus; the first is SETPOINT menu, using (+ and -) buttons you will scroll all 4 menus.

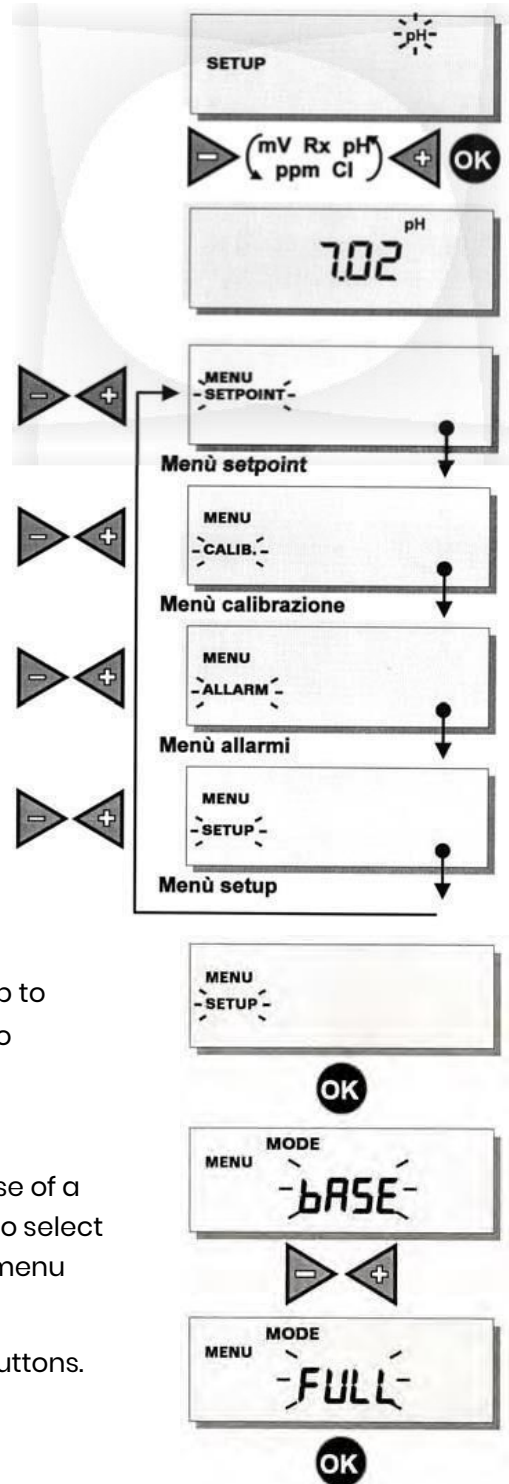

To enter in SETUP menu scroll all menus with (+ and -) buttons up to reach the desired menu (on display will show SETUP), press OK to confirm.

On display will appear the last setting previously selected; in case of a new product, the pump has by default BASE (simplified menu), to select the type of parameter to control it is necessary to pass in FULL menu (complete menu - expert users).

To shift from BASE to FULL modes and vice versa, press + and - buttons.

When FULL appears on the display press OK to confirm.

After around 2 seconds the selection is acquired by the pump and the operator can decide whether to quit SETUP menu or to continue for additional setting. In the view of selecting pH, Redox or Free Chlorine measuring, check next paragraph.



7.1.1 MEASURE TYPE SELECTION

Once pressed OK the pump goes in SETUP mode. In this mode is possible to select the type of control (measure) that it want to effect.

This mode is a loop among pH, Redox and ppm; as default Ph will flash. Acting on (+ and -) buttons, user can select among 3 possibilities, (pH, RX mV, ppm Cl). Pressing the button OK is confirmed the possibility selected choice. The pump will enter in Password menu.

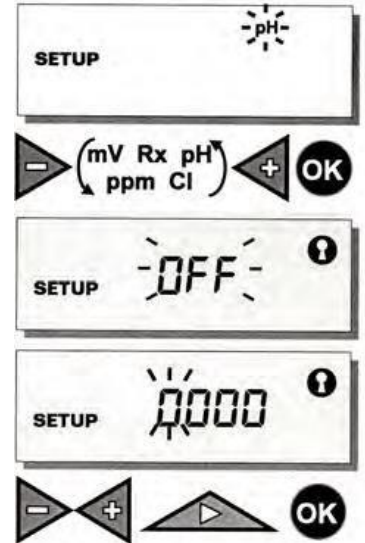

7.1.2 PASSWORD

As default, protection password is disabled. It is possible for the user to set a protection password of the device during the definition of Setup.

After pressed OK in SELECT mode, the pump goes in password mode (only if FULL mode is active). Display show OFF (password disabled).

Pressing OK will exclude the password, otherwise if the buttons (+ or -) are pressed, password mode is enabled.

Pressing OK button, the display will show 0000. To set a password use (+ or-) buttons to increase or decrease value that composes the password. To shift from the first digit to the followings ones press Right Arrow. Press OK to confirm the password.

7.1.3 CHOICE OF INPUT LEVEL/FLOW

After the password has been determined, it is possible to set up the type of sensor that is necessary to install the pump:

When a level sensor is needed to be connected, the LEVEL warning will appear, on the other hand when it is necessary to connect a proximity sensor this icon  will appear.

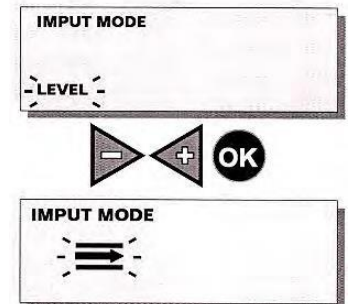

7.1.4. TEMPERATURE SELECTION BETWEEN CELSIUS AND FAHRENHEIT DEGREES

Continuing in the SETUP menu, pressing OK, it is possible to select temperature reading between Celsius and Fahrenheit degrees (°C or °F).

To shift use (+ or -) buttons.

Pressing OK to confirm and to save the choice.

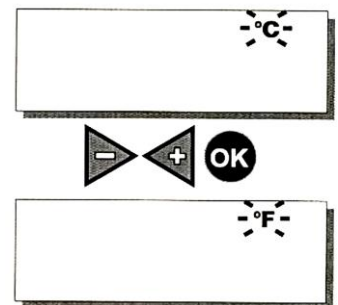

7.1.5 CALIBRATION EXIT DELAY

Thanks to this function user can select the time the pump will use to quit from calibration phase setting to come back to the main measuring display.

Using + and - it's possible to set the delay time, from 0 second to 99 min.

59 sec. To shift from minutes to seconds, press Right arrow.

Press OK to confirm.



7.1.6 SWITCHING-ON DELAY

To solve the problem of inertia of some electrodes or plant installation, the pump has the possibility to set a delay time from pump switching-on to the measuring and control moment. Using + and - it's possible to set the delay time, from 0 to 99 min. 59 sec. To shift from minutes to second press Right arrow. Press OK to confirm.





7.2 MEASURING CALIBRATION

To calibrate the pump integrated controller, user has to adjust two calibration points for any kind of parameter, i.e. pH, Redox or Chlorine.

To enter in CALIB. menu, from measuring mode, press OK button then (the + button), on display CALIB. will flash, press OK button again to confirm.

On display will appear POINT 1

pH PROCEDURE:

- Dip the electrode in buffer solution 7.00.
- Adjust the value on the display up to reach 7.00 with + and - buttons.
- Press OK to save the data. On display will appear POINT 2.
- Dip the electrode after washing with tap water in the second buffer solution; we suggest 4.00 or 9.00 pH.
- Adjust the value on the display up to reach the second buffer solution
- Adjust the value on the display up to reach 7.00 with + and - buttons.
- Dip the electrode in buffer solution 7.00.
- Value with + and - buttons.
- Press OK to save the data.

REDOX (mV) PROCEDURE:

- Put in short circuit the BNC connector. Using a metal wire, connect the core pin with the external cylinder part.
- Adjust the value on the display up to reach 0 using + and - buttons.
- Press OK to save the data
- On the display will appear POINT 2
- Dip the electrode in a buffer solution. We suggest 250, 475 or 650mV.
- Adjust the value on the display up to reach the buffer solution value using + and - buttons.
- Press OK to save the data.

CHLORINE PROCEDURE (ppm Cl):

- Put in a short circuit BNC connector (as shown in figure) using a copper wire.
- Adjust the value on the display up to reach 0 using + and - buttons.
- Press OK to save the data, on display will appear POINT 2
- Dip the chlorine probe in a water with dissolved chlorine. Using DPD method measure the chlorine level.
- Adjust the reading on display with + and - buttons up to reach the value measured
- It's important to have a good amount of chlorine for this point of calibration, we suggest at least 1ppm.
- Press OK to save data.



7.3 SETPOINT SETTING

To have the pump operative it's mandatory set the following data: Setpoint values, type of dosing, hysteresis, manual or proportional dosing.

There are two different Setpoint setting procedures; if the pump setup activated FULL mode or BASE mode. Let's start from the setting with BASE menu activated (see Chapter 7.1)



7.3.1 SETPOINT VALUE

From measuring status, pressing OK, the pump will go in SETPOINT programming phase. Setpoint icon will flash. Pressing OK again, the setpoint value saved will flash and can be adjusted using + and - buttons. Pressing OK, the setpoint value will be memorized. The pump automatically will go in DIRECTION menu



7.3.2 DIRECTION MENU

In this menu, has to set if the pump has to dose above the setpoint or below this value. For instance to reduce pH value, dosing an acid chemical, the direction arrow has to point down. In this way the pump will be active, dosing, when the pH value is higher than the setpoint previously set. For Redox (or chlorine) if the pump has to dose up to reach a certain quantity of oxidant (or chlorine), the direction arrow has to point in aloft. To select the direction of the arrow, use the (+ and -) buttons. Pressing OK the direction will be memorized.

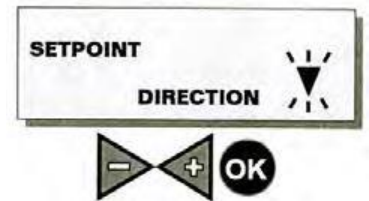

The pump automatically will go in Manual/Proportional menu (ON-OFF or PROP.) or in Hysteresis menu, this depends on SETUP setting. If FULL menu has been activated, Hysteresis menu will appear (go to paragraph 7.3.6), otherwise if BASE menu has been activated, Hysteresis menu will be not present and the pump will be driven with hysteresis default values that are:

0,1 pH; 10 mV; 0.05 ppm

7.3.3 MANUAL OR PROPORTIONAL MODE (BASE MENU ACTIVATED)

After selected direction of the dosing, the pump will show ON-OFF or PROP. flashing. With + or - buttons it's possible to shift among them.

ON-OFF - When the pump has to dose it will run at flow rate selected by the user in Flow rate setting, and it stops at the Setpoint.

PROP. - In this mode the pump will dose proportionally to the setpoint value. The pump starts dosing over Setpoint (determined by hysteresis), increasing its speed up to the MAX FREQUENCY ADJUSTMENT use will set after pressing OK from this menu.

Use + and - to select the operative mode.

Press OK to confirm the selection. Following will be described these two modes:

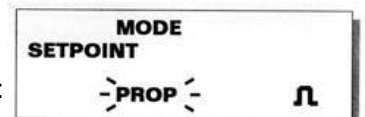
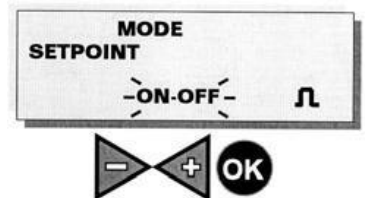



7.3.4 FREQUENCY ADJUSTMENT

If the user has select Manual mode (ON-OFF), after pressing OK button, the pump will pass in Frequency adjustment menu. User has to set the flow rate of the pump, from 0 to 100% of maximum frequency.

Use (+ e -) buttons to select the desired flow rate percentage. Pressing OK the pump will save data and go out from Setpoint mode. It will be enough to press ESC button to go in metering mode.

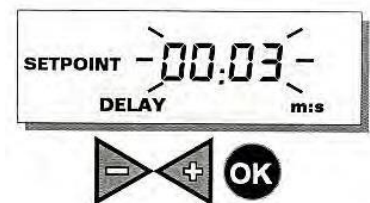
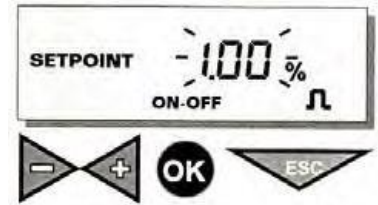

Only in ON/OFF mode is it possible to define the time delay with regards to the Setpoint start-up, press the (+ and -) keys to set the time in minutes and seconds. Press the OK key to confirm the values.

7.3.5 MAX FREQUENCY ADJUSTMENT

Self controls its flow rate from this point, up to the setpoint where it stops dosing (please follow next 3 steps).

If the user has select Proportional mode (PROP.), after pressing OK button, the pump will pass in Max frequency adjustment menu. User has to set at which pH, Redox or Chlorine level the pump has to dose at the maximum speed. The pump

Use (+ and -) buttons to select the maximum measure value to which the pump has to dose at the maximum frequency (STEP 1).

Pressing OK the pump will save data and go out from Setpoint mode. It will be enough to press ESC button to go in metering mode (STEP 2).

Pressing OK key, the device allows the setting of the minimum frequency at the Setpoint (STEP 3).

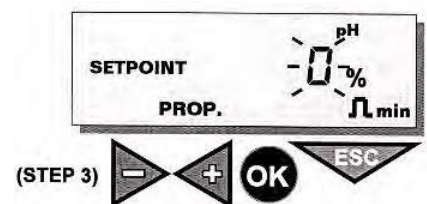
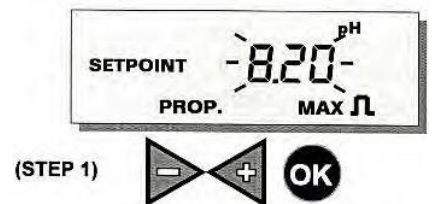

LET'S DESCRIBE NOW THE SETPOINT PROCEDURE IN CASE FULL MENU ACTIVATED (SEE PARAGRAPH 7.1)

7.3.6. HYSTERESIS MENU

After selected direction of dosing, user has to adjust the hysteresis value: distance from the setpoint value, over this value the pump starts or stops its dosing.

After pressing the OK button the instrument goes to Hysteresis menu setting. Press + and - to set the desired hysteresis value.

Press OK button to confirm and to save value.

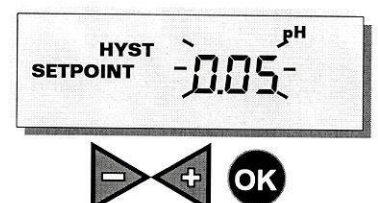



7.3.7 4÷20 mA CALIBRATION

The pump is equipped with a 4÷20 mA output for recorder or other device connection. Here in the picture is showed pH, but for each parameter pH, Redox or Chlorine pump will show corresponding pH, mV RX or ppm Cl on the display.

After confirming with OK the Maximum Frequency Adjustment, the next step is to adjust two measure values that correspond to the mA output.

Press + and - to set the value of the measure to which it has to correspond 4mA output.

Press OK to confirm and to save data.

Press + and - to set the value of the measure to which it has to correspond 20mA output.

Press OK to confirm and to save data.

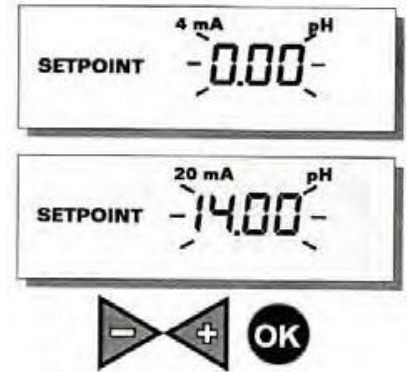

7.4 ALARM SETTING

It is possible to plan three different types of alarm pump:

- 1 MAX: User can set at which maximum value the pump has to go in alarm mode. When the pump will go over this value, on the display, Alarm message will flash, Alarm Led will flash.
- 2 min: User can set at which minimum value the pump has to go in alarm mode. When the pump will go over this value, on the display, Alarm message will flash, Alarm Led will flash.
- 3 OVER: Overdosing alarm. For any kind of problems may occur in the plant (wrong calibration, dirty or broken probe, etc.) if the pump doesn't reach the Setpoint in OVER ALARM TIME, the pump stops the dosing. On the display Alarm message will flash, Alarm Led will flash.

The alarms mentioned above after a power supply loss will be off if the alarm conditions will be not present at the powering back of the pumps. Alarm signal is turned off by pressing the ESC button.

To enter in ALARM menu follow the procedure described in paragraph 7.1 - PUMP SETUP.

When ALARM menu is reached, press OK to enter in submenus.

7.4.1 MAXIMUM ALARM SETTING

On the display will appear MAX and the value of measure will flash.

Press (+ and -) to adjust the maximum value of the measure.

Press OK to confirm and to save data.

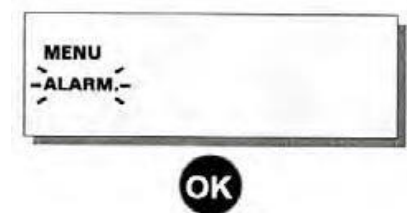

7.4.2 MINIMUM ALARM SETTING

On the display will appear "min" and the value of measure will flash.

Press + and - to adjust the minimum value of the measure.

Press OK to confirm and to save data.

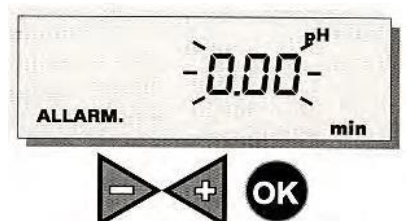



7.4.3 OVERDOSING ALARM SETTING

On the display will appear OVER and time counter (h:min) will flash alarm. Press (+ and -) to adjust the time, over which the pump will go in alarm. Press OK to confirm and to save data. This will end the alarm setting. Press ESC to return in measure mode.



7.5 RESET PROCEDURE

The pump is equipped with two RESET procedures. It can be used any time the user has to reset some or entire calibration parameters.

Following are described all the steps for partial RESET and for total RESET:

- Turn off and turn on the pump.
- Press once the OK button, it will appear SETPOINT menu.
- Press at the same time button (+ and button -) user has 15 seconds to make this operation after pressed OK button).
- On the display will appear RESET.

7.5.1 PARTIAL RESET PROCEDURE

With this procedure a partial reset will be activated, the pump return to the default settings but all the calibration parameters will be saved.

- On the display will appear RESET.
- Press twice - button and then Right arrow button.
- On the display will appear SELECT.

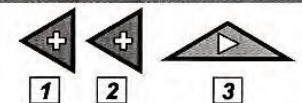
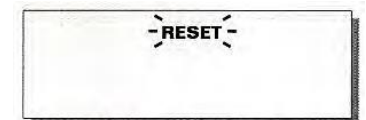
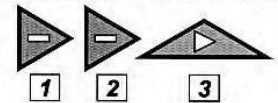
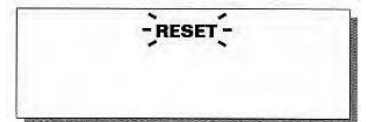

7.5.2 TOTAL RESET PROCEDURE

With this procedure a total reset will be activated, the pump return to the default settings and all the calibration parameters will be lost.

- On the display will appear RESET
- Press twice + button and then Right arrow button
- On the display will appear SELECT

ATTENTION: after 15 seconds from entry in SETPOINT menu it isn't possible to activate the reset procedure. Therefore the user has to turn off and then turn on the pump and to repeat the reset procedure.

7.6 STAND-BY PROCEDURE

With this procedure the pump is put on stand-by.

- Hold down key + and - until Stand-by appears on the display
- Press twice - button and then Right arrow button

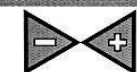
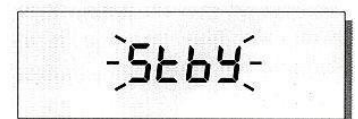



8.0 TROUBLE-SHOOTING COMMON TO SDP SERIES PUMPS

8.1 MECHANICAL FAULTS

As the system is quite robust there are no apparent mechanical problems. Occasionally there might be a loss of liquid from the nipple because the tube nut has loosened, or more simply the discharge tubing-has broken.

Very rarely there may be losses caused by the breakage of the membrane, or by the membrane seals in which case they have to be replaced by disassembling the four screws of the pump head (fig. 10), when re-mounting the pump head ensure that the screws are replaced properly, along with "O" ring. After repair, the metering pump will need to be cleaned of additive residues which can damage the pump casing.

8.1.1 THE METERING PUMP GIVES PULSES BUT THE ADDITIVE IS NOT INJECTED

- a. Dismount the suction and discharge valves, clean them and replace, see position (fig. 10). Should the valves be swollen, check valves material against our chemical resistance compatibility chart and fit correct valves. Standard valves are Viton. Upon request ball check valve, can be supplied.
- b. Check clogging of the filter.

ATTENTION: When removing the metering pump from the plant, be careful as there might be some residual additive in the discharge hose.

8.2 ELECTRICAL FAULTS

8.2.1 ALL LEDS OFF, THE PUMP DOES NOT PULSE

Check power supply (socket, plug, power switch ON), if the pump doesn't work contact manufacturer Customer Service, Dealer or Distributor.

8.2.2 GREEN LED (POWER) ON, RED LED (PULSE) OFF, THE PUMP DOES NOT PULSE

Check that the pump is not in Alarm (yellow LED flashing, on display LEVEL has appeared), verify the calibration's parameters. If the pump doesn't work contact Manufacturer Customer Service, Dealer or Distributor.

8.2.3 PUMP PULSES ARE NOT CONSTANT

Check that supply voltage is within +/- 10% of rated voltage.

8.2.4 THE DOSING PUMP GIVES ONLY ONE PULSE

Disconnect the equipment and contact manufacturer Customer Service, Dealer or Distributor.

PUMP SECTIONAL DRAWING

Pump construction

TypeSMF

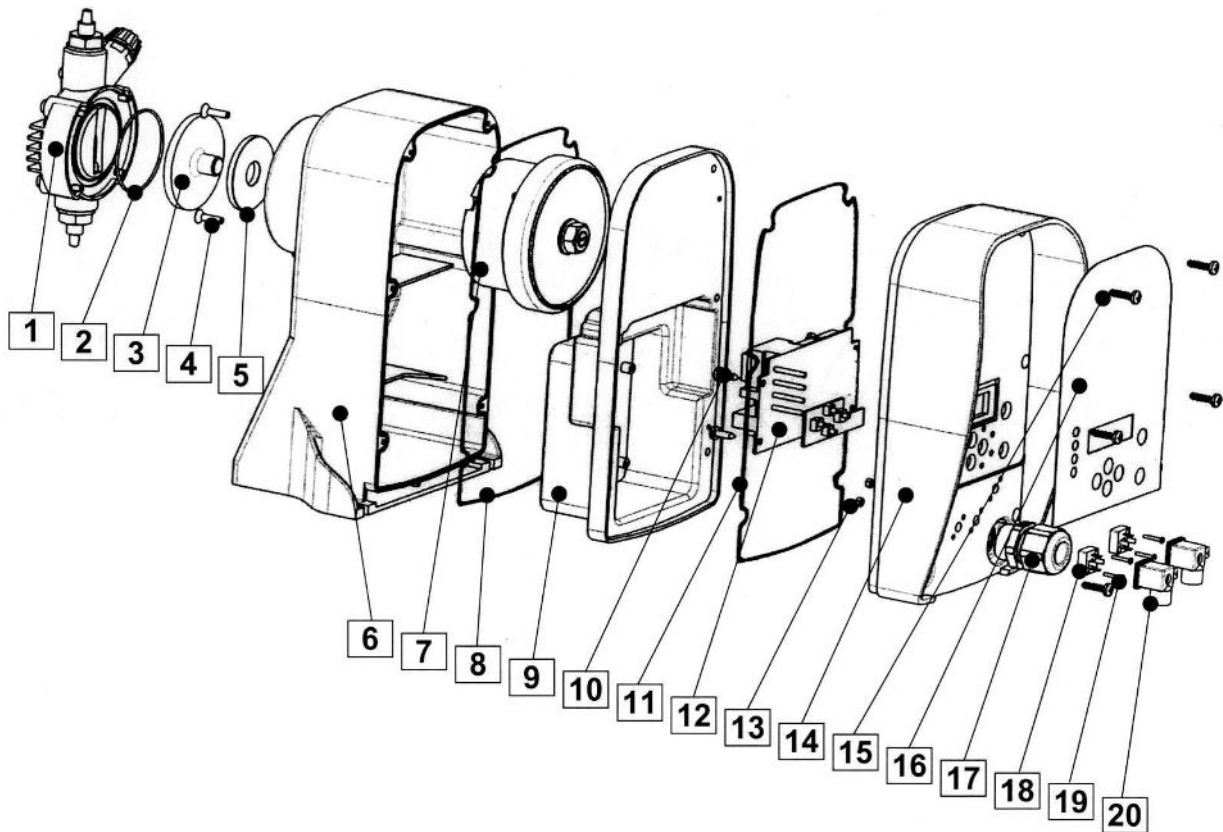

Item	N°	Spare part	Description
1	1		Pump head
2	1		O-ring gasket
3	1		Diaphragm
4	2		Screw
5	1		Flange
6	1		Pump body
7	1		Electromagnet
8	1		Gasket
9	1		Separation panel
10	4		Screw
11	1		Gasket
12	1		Electronic card
13	4		Nut
14	1		Control panel
15	6		Screw
16	1		Push-button panel
17	1		Cable gland
18	2		Male connector
19	4		Screw
20	2		Female connector

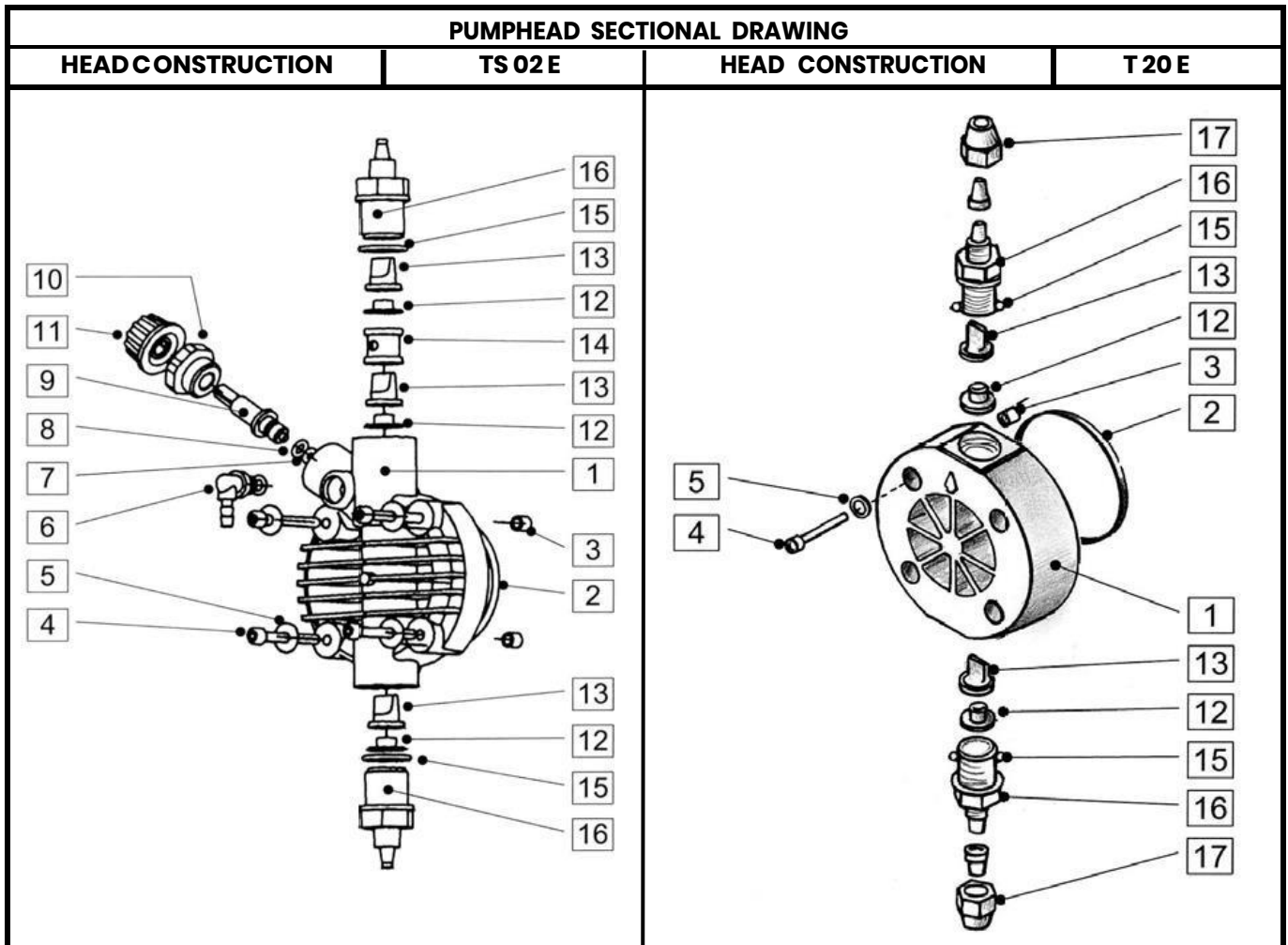

Item	N°	Spare part	Description
1	1	X	Pump head
2	1	X	O-ring gasket
3	4		Pump head bush
4	4		Screw
5	4		Flat washer
6	1		Air bleed nipple
7	1	X	O-ring gasket
8	1	X	O-ring gasket
9	1		Air bleed screw
10	1		Air bleed cap
11	1		Air bleed knob
12	3	X	Valve guide
13	3	X	Valve
14	1		Air bleed spacer
15	2	X	O-ring gasket
16	2	X	Nipple
17	2	X	Tube nut



COMPONENTS DESCRIPTION

VALVE			INJECTION VALVE			FILTER		
V 02			VI 02			F 20		
Item	Spare part	Description	Item	Spare part	Description	Item	Spare part	Description
12	X	Valve guide	1		Injection fitting	1		Cover
13	X	Valve	2	X	Viton sleeve	2		Screen strainer
15		O-ring gasket	/			3	X	Filtering wool
16		Valve Nipple	/			4		Separate ring
17		Tube nut	/			13	X	Valve

ELECTROMAGNET

M 80 - M 90

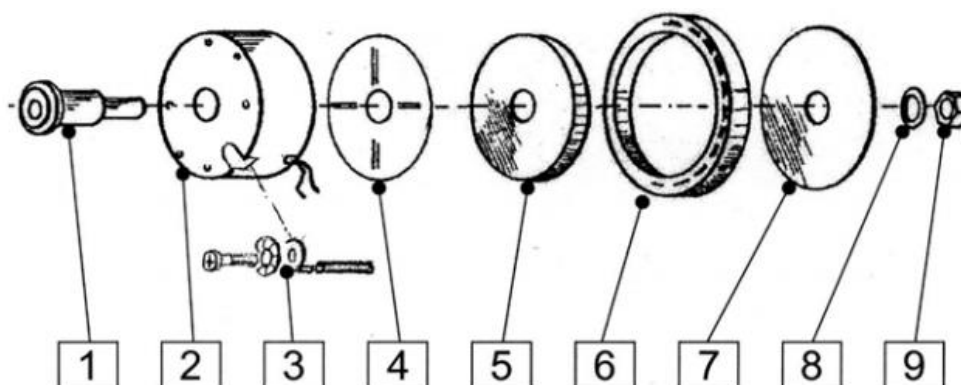

Item	N°	Spare part	Description
1	1	X	Plunger
2	1		Electromagnet
3	1		Electromagnet cable terminal
4	1	X	Aircore
5	1		Collar
6	1	X	Preloading ring
7	1	X	Cup shaped spring
8	1		Washer
9	1		Nut



PUMPHEAD SECTIONAL DRAWING			
HEAD CONSTRUCTION	TS 02 E	HEAD CONSTRUCTION	T 20 E
Item	N°	Spare part	Description
1	1		Pump head
7	1	X	O-ring gasket
9	6		Flat washer
14	6		Screw



TO MEASURE  TO KNOW

Nieuwkoop BV

Aalsmeerderweg 249 -S
1432 CM AALSMEER

0297 325836

info@nieuwkoopbv.nl
www.meten.nl



NIEUWKOOP